



Dichtungen
 Sealing Strips



Schnittzeichnungen / Section drawings

Seite Page	Fenstersysteme - Bezeichnungen / Window Systems - terms		GOLD-Type Ref.: Nr. No.
1	IV56 EURO FENSTER SÜD	IV56 EURO WINDOW SOUTH	2156
2	IV68 EURO STANDARD	IV68 EURO STANDARD	2110
3	IV68 EURO SOFTLINE FENSTER	IV68 EURO SOFTLINE WINDOW	2150
4	IV68 EURO SOFTLINE 13mm ACHSMASS	IV68 EURO SOFTLINE 13mm CENTRE DISTANCE	2710
5	IV78 RUSSISCHES FENSTER GOST NORM	IV78 RUSSIAN WINDOW GOST NORM	2808
6	IV92 DREIFACH FALZ FENSTER	IV92 THREEFOLD REBATE WINDOW	2850
7	IV68 SPANISCHES FENSTER	IV68 SPANISH WINDOW	2180
8	IV68 FENSTER - ANGEFRÄSTE GLASLEISTE	IV68 WINDOW - FIXED GLAZING BEAD	2163
9	IV101 PASSIVHAUS FENSTER	IV101 HIGH INSULATION WINDOW "PASSIV HOUSE"	2300
10	IV68 WENDE FENSTER	IV68 CENTRE PIVOT WINDOW	2160
11	IV68 SCHWING FENSTER	IV68 PIVOT WINDOW	2170
12	EV44/42/94 RUSSISCHES KASTENFENSTER	EV44/42/94 RUSSIAN DOUBLE WINDOW	2820
13	EV68/68 KASTENFENSTER "ST.PETERSBURG"	EV68/68 BOX TYPE WINDOW "ST.PETERSBURG"	2880
14	IV92/66,5 NORWEGISCHES FENSTER	IV92/66,5 NORWEGIAN WINDOW	3510
15	IV116/56 DÄNISCHES FENSTER	IV116/56 DANISH WINDOW	2520
16	EV115/32IV55 SCHWEDISCHES FENSTER KFI	EV115/32IV55 SWEDISH WINDOW KFI	2525
17	EV115/32IV55 SCHWEDISCHES FENSTER KFU	EV115/32IV55 SWEDISH WINDOW KFU	2526
18	IV125/56 VERTIKAL SCHIEBE FENSTER	IV126/56 DOUBLE - HUNG WINDOW	2720
19	IV110/42 FINNISCHES HOLZ-ALU FENSTER	IV110/42 FINNISH WOOD-ALU WINDOW	2730
20	IV68 HAUSTÜRE IN HOLZ FENSTER-BASIS	IV68 WOODEN FRONT DOOR BASED ON WINDOW	4580
21	IV68 HAUSTÜRE IN HOLZ EINFACHFALZ	IV68 WOODEN FRONT DOOR SINGLE REBATE	4900/4500
22	IV67 HAUSTÜRE IN HOLZ EINFACHFALZ	IV67 WOODEN FRONT DOOR SINGLE REBATE	4960
23	IV68 HAUSTÜRE IN HOLZ AUSSEN ÖFFNEND	IV68 WOODEN FRONT DOOR OUTWARD OPENING	4995
24	IV116/56 SKANDINAVISCHES HAUSTÜRE	IV116/56 SCANDINAVIAN FRONT DOOR	4991
25	IV130/63 FINNISCHE HAUSTÜRE	IV130/63 FINNISH FRONT DOOR	4992
26	IV56/68 HEBE-SCHIEBE-TÜR	IV56/68 LIFT-SLIDE-DOOR	4700
27	26/40 INNENTÜRE - TÜRFUTTER AUSFÜHRUNG	26/40 INTERIOR DOORS - DOOR CASE DESIGN	709
28	54/40 NEBENEINGANGSTÜRE BLOCKFUTTER	54/40 SIDE-ENTRANCE DOOR - DOOR FRAME	710

IV56 EURO FENSTER SÜD
IV56 EURO WINDOW SOUTH

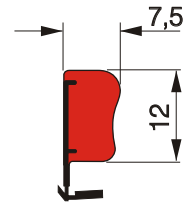
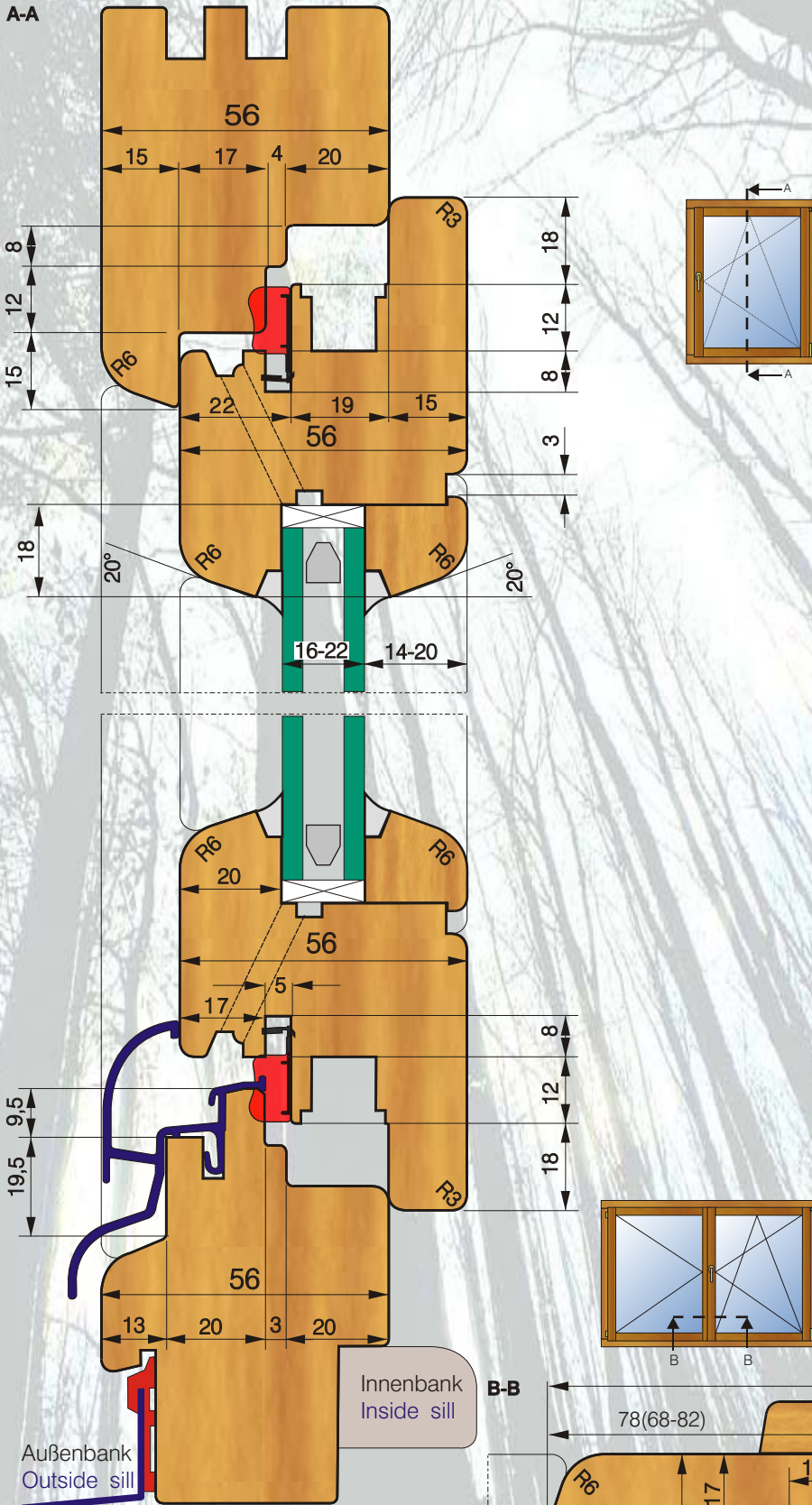

QL-3053

Falz Rebate: 12mm
 Nute Groove: 4-5x8mm
 Spalt Gap: 5mm

Stulpdichtung DX-1362
 Seal for FRENCH windows



Falz Rebate: 18-20mm
 Nute Groove: 4-5x8mm
 Spalt Gap:

Q-LON Abdeckkappe
 Q-LON Cover Cap

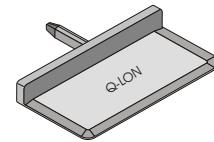

Ventilationsbürste
 Ventilating Brush

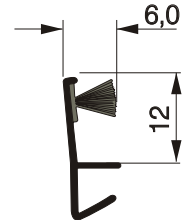

DX-1316

Falz Rebate: 12mm
 Nute Groove: 4-5mm
 Spalt Gap: 5mm

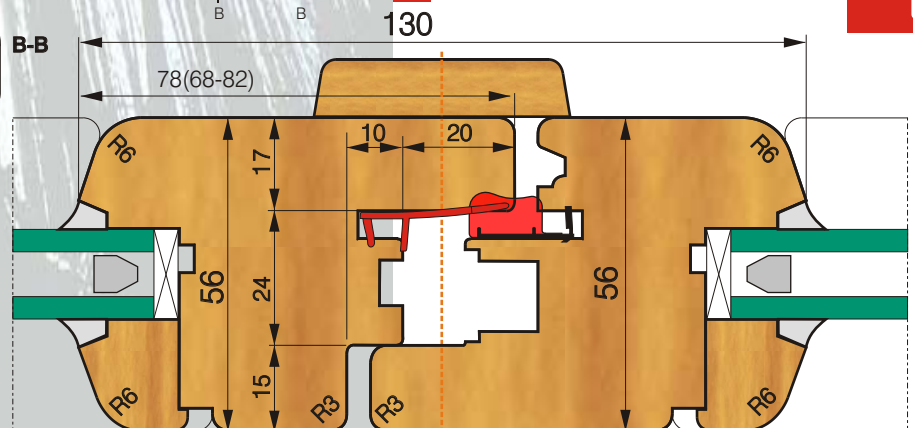

IV68 EURO STANDARD
IV68 EURO STANDARD

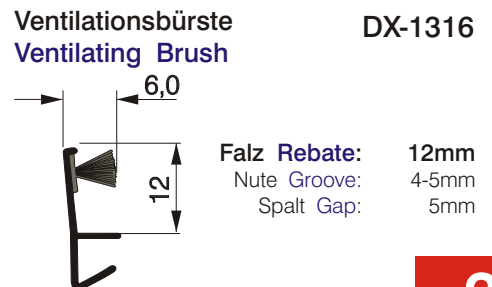
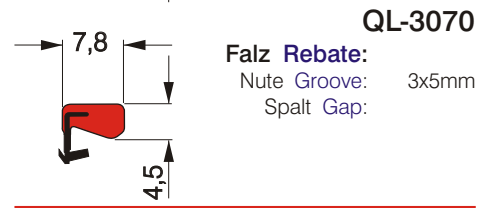
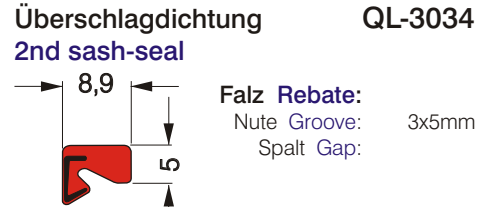
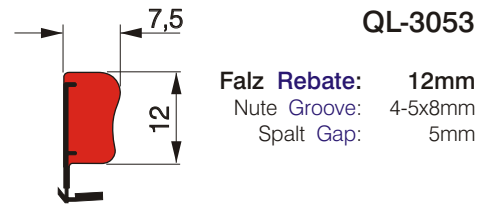
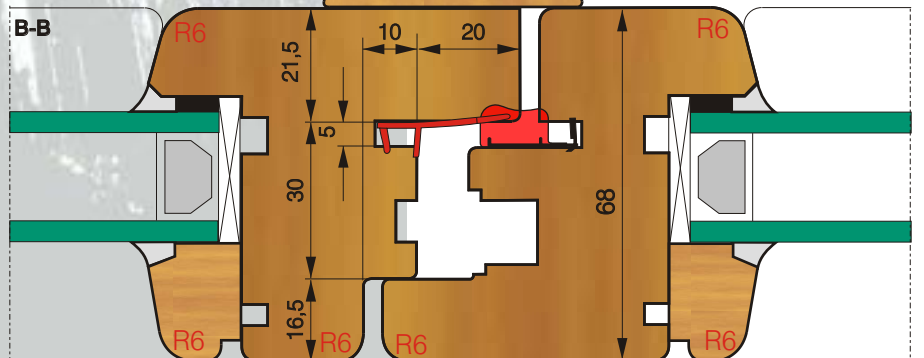
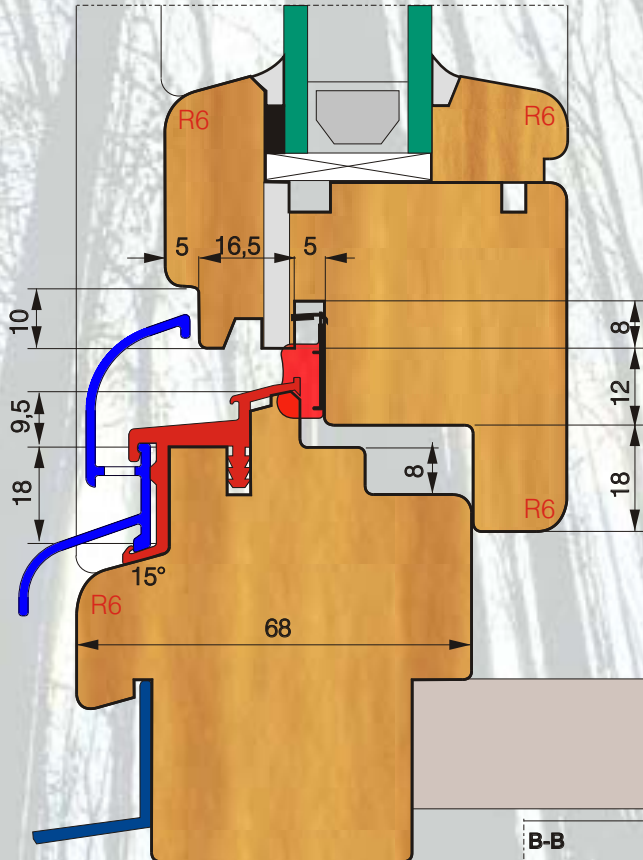
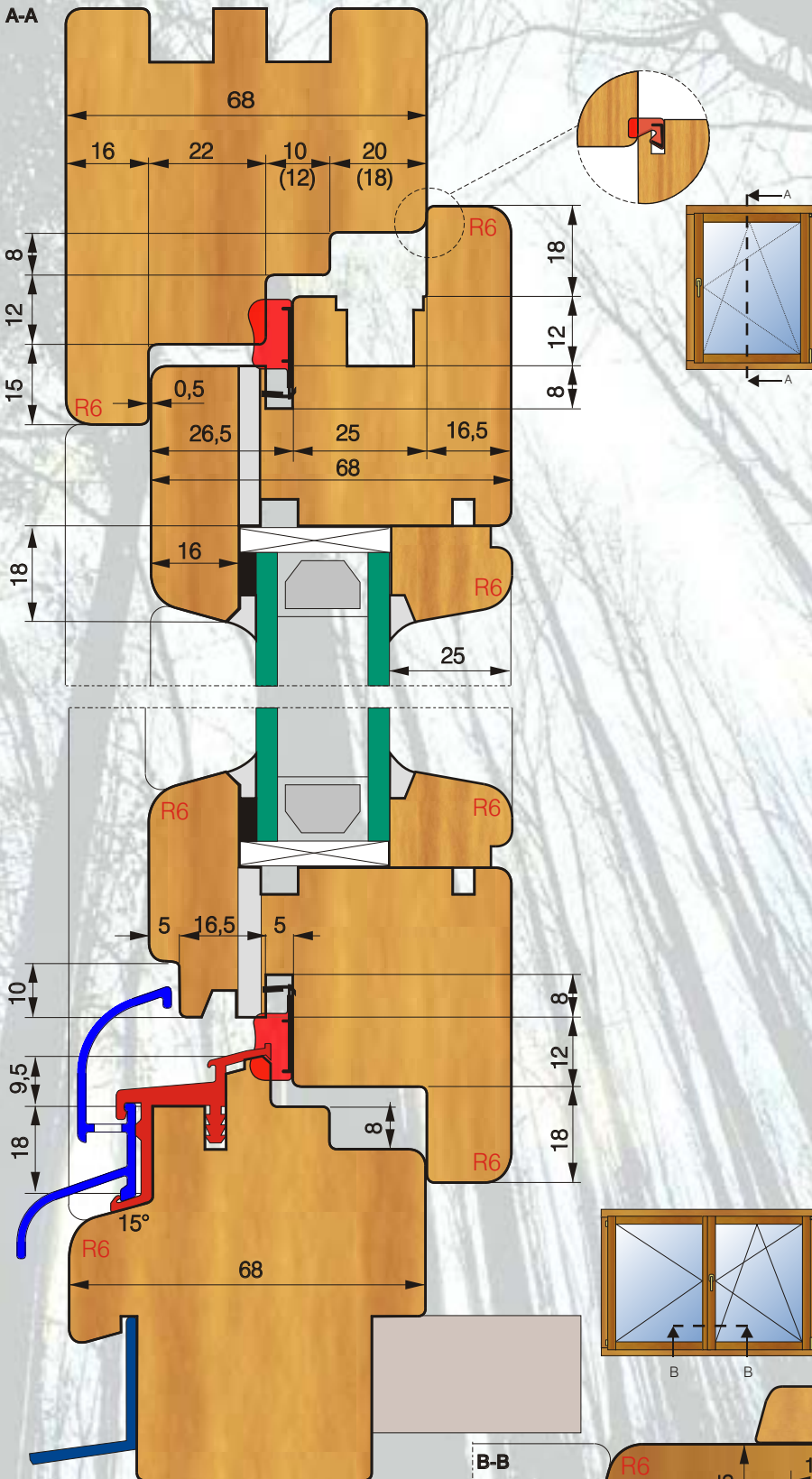

IV68 EURO SOFTLINE 13mm ACHSMASS
IV68 EURO SOFTLINE 13mm CENTRE DISTANCE

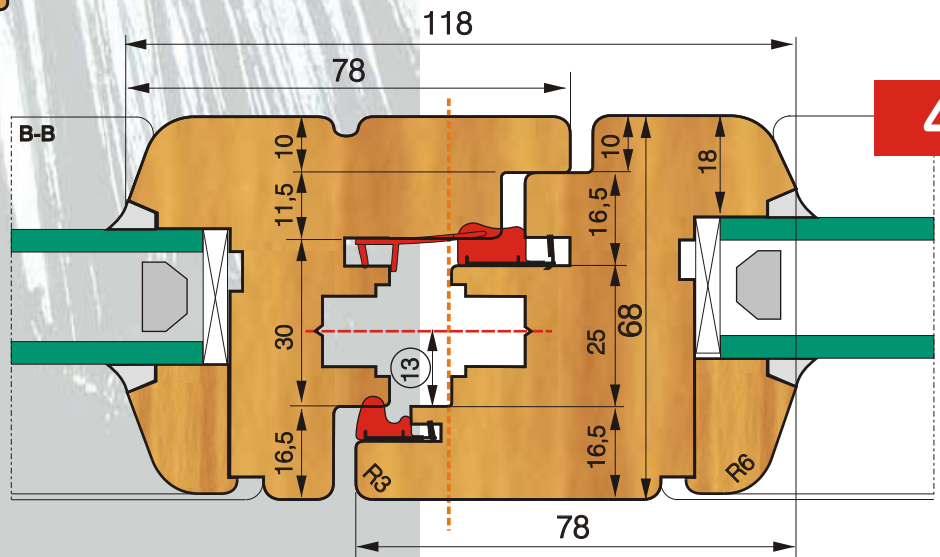
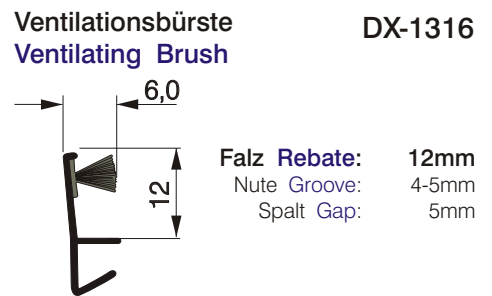
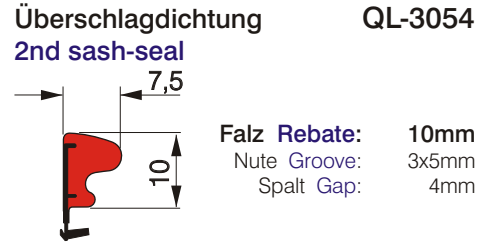
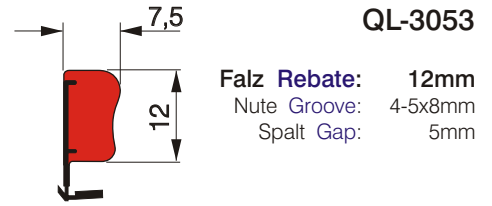
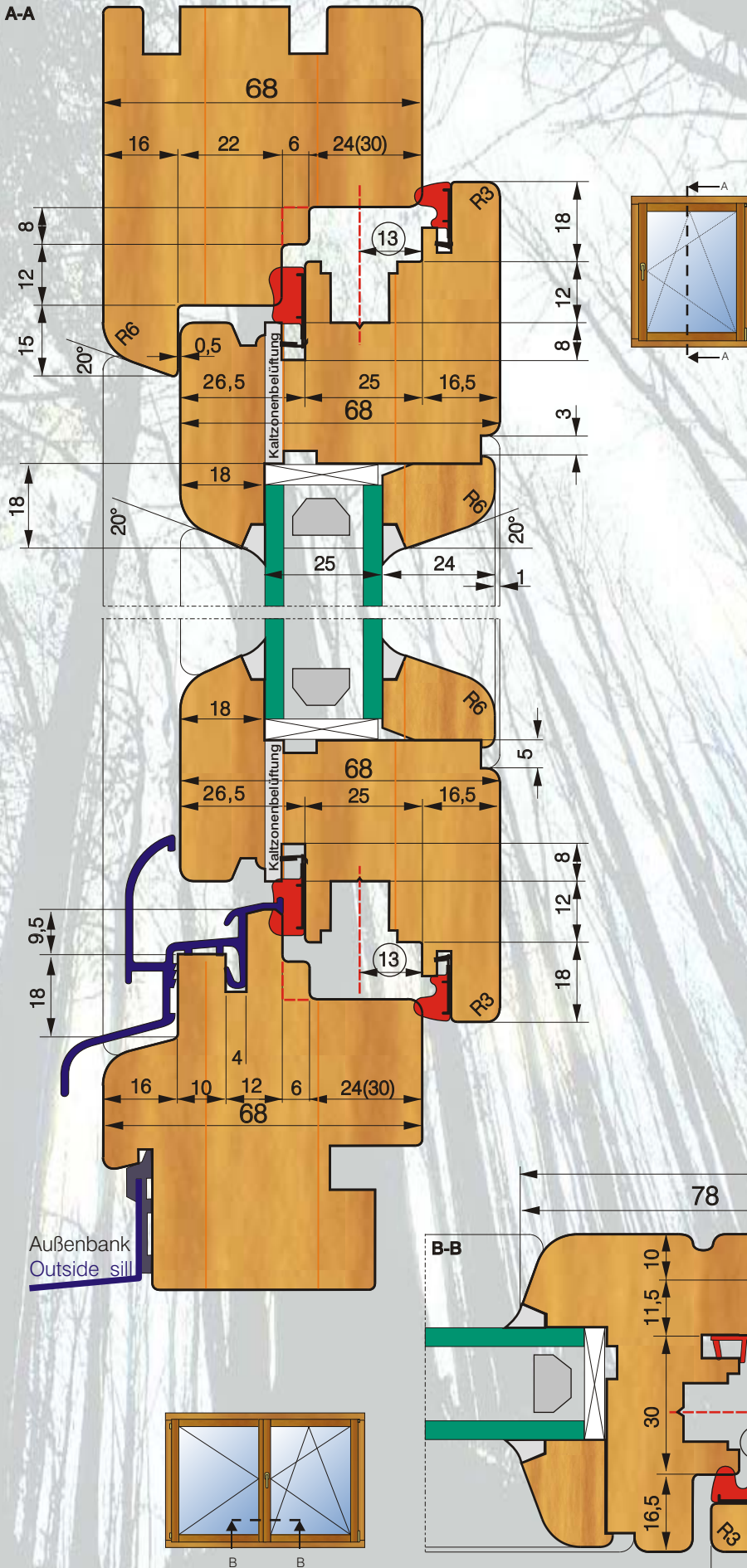

IV78 RUSSISCHES FENSTER GOST NORM
IV78 RUSSIAN WINDOW GOST NORM

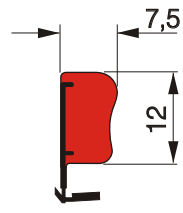
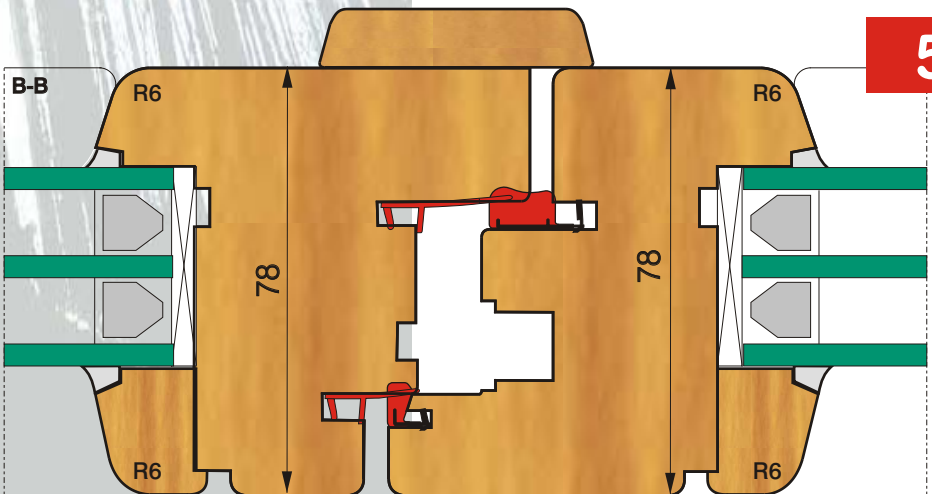
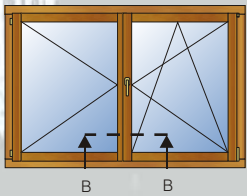
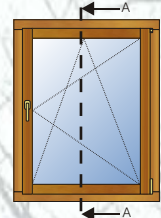
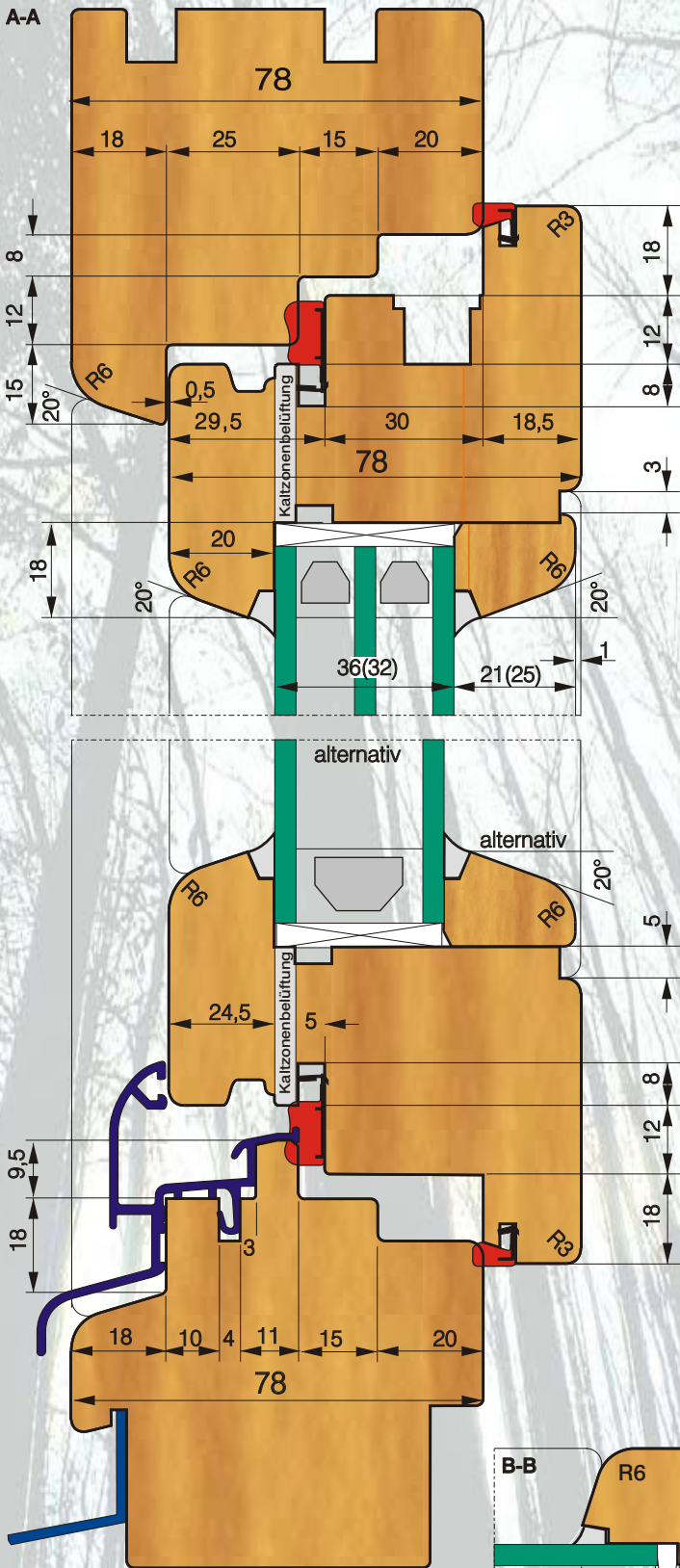

QL-3053

Falz Rebate: 12mm
 Nute Groove: 4-5x8mm
 Spalt Gap: 5mm

Überschlagdichtung
2nd sash-seal

QL-3034

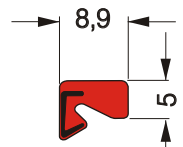

Falz Rebate: 3x5mm
 Nute Groove: 3x5mm
 Spalt Gap: 3x5mm

QL-3070

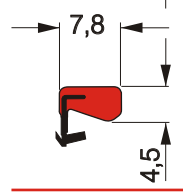

Falz Rebate: 3x5mm
 Nute Groove: 3x5mm
 Spalt Gap: 3x5mm

Stulpdichtung
Seal for FRENCH windows

DX-1362



Falz Rebate: 18-20mm
 Nute Groove: 4-5x8mm
 Spalt Gap: 4-5x8mm

Q-LON Abdeckkappe
Q-LON Cover Cap

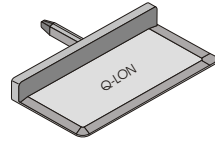

Ventilationsbürste
Ventilating Brush

DX-1316

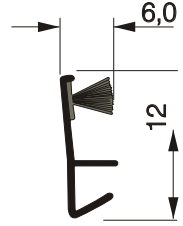

Falz Rebate: 12mm
 Nute Groove: 4-5mm
 Spalt Gap: 5mm

IV92 DREIFACH FALZ FENSTER
IV92 THREEFOLD REBATE WINDOW

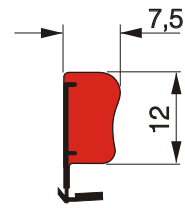
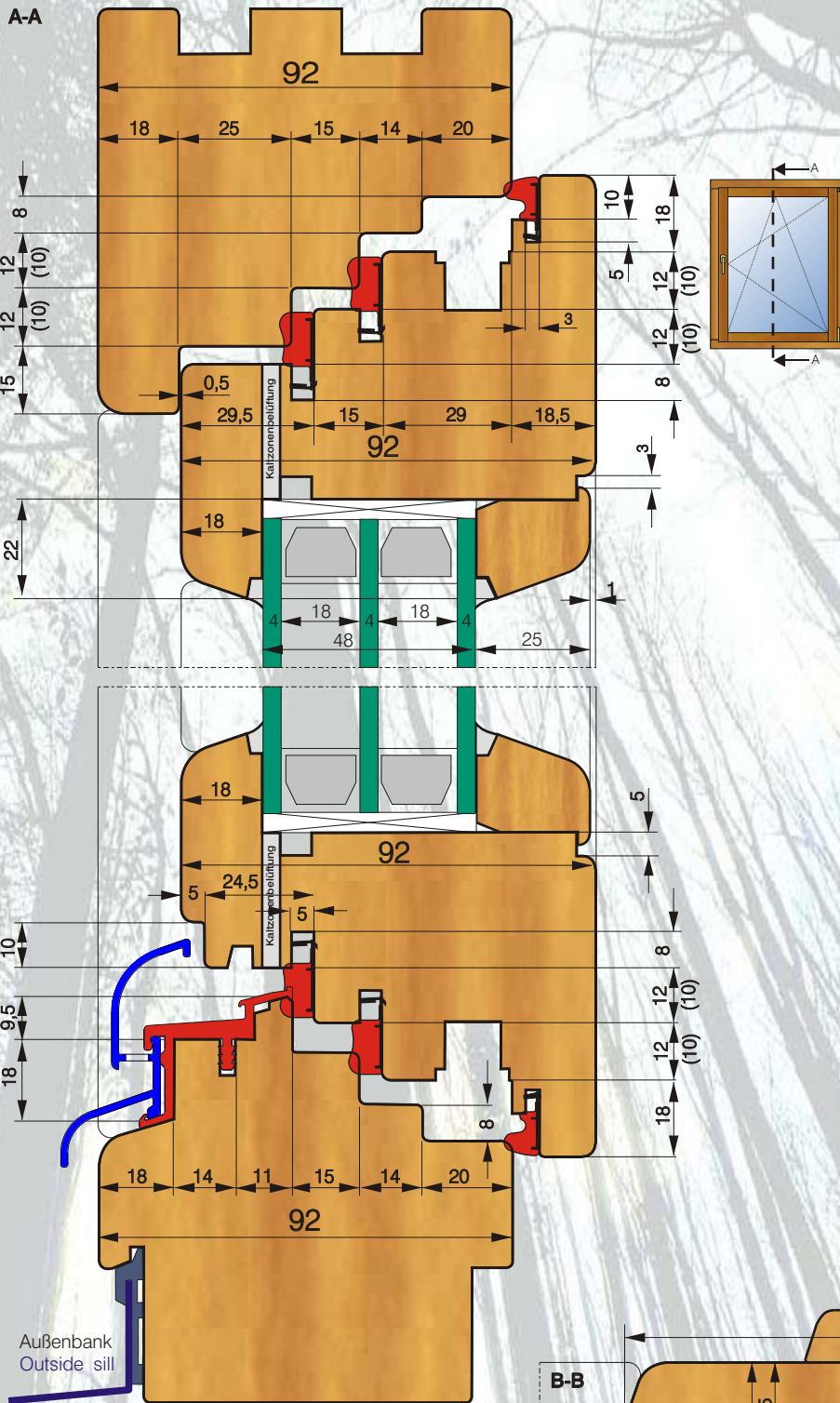

QL-3053

Falz Rebate: 12mm
Nute Groove: 4-5x8mm
Spalt Gap: 5mm

Überschlagdichtung
2nd sash-seal

QL-3072
QL-3079

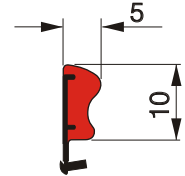

Falz Rebate: 10mm
Nute Groove: 3-4x7mm
Spalt Gap: 3mm

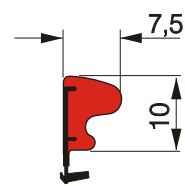

QL-3054

Falz Rebate: 10mm
Nute Groove: 3x5mm
Spalt Gap: 4mm

Stulpdichtung
Seal for FRENCH windows

DX-1362



Falz Rebate: 18-20mm
Nute Groove: 4-5x8mm
Spalt Gap:

Ventilationsbürste
Ventilating Brush

DX-1316

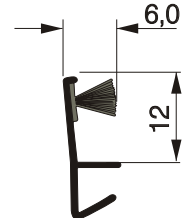

Falz Rebate: 12mm
Nute Groove: 4-5mm
Spalt Gap: 5mm

Q-LON Abdeckkappe
Q-LON Cover Cap

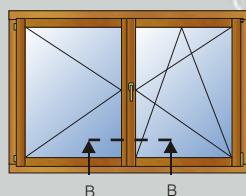
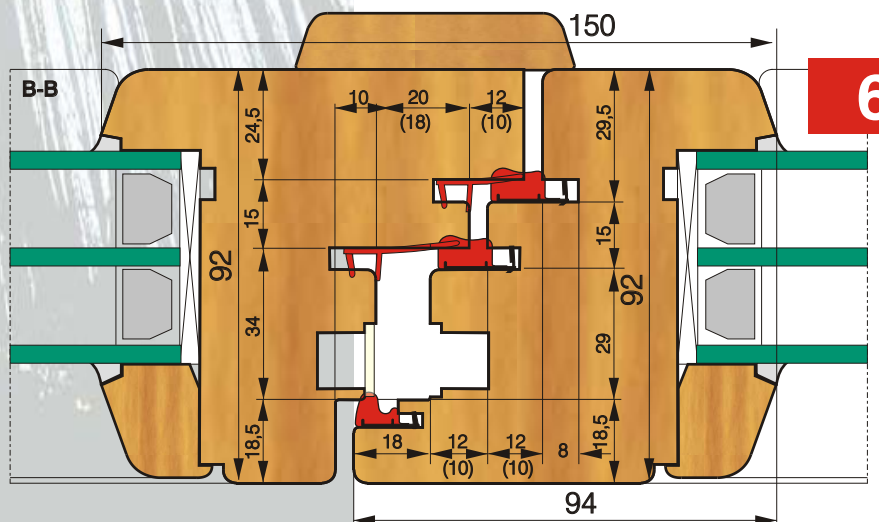
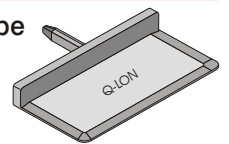

IV68 SPANISCHES FENSTER
IV68 SPANISH WINDOW

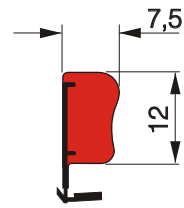
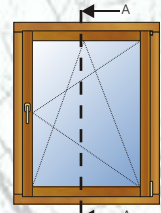
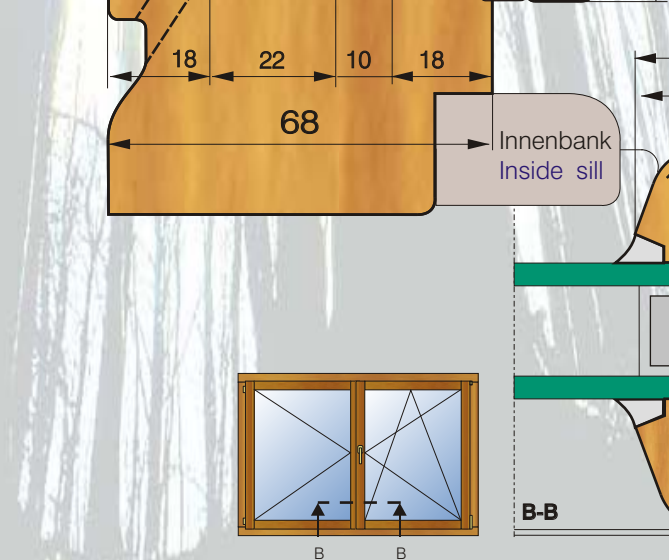
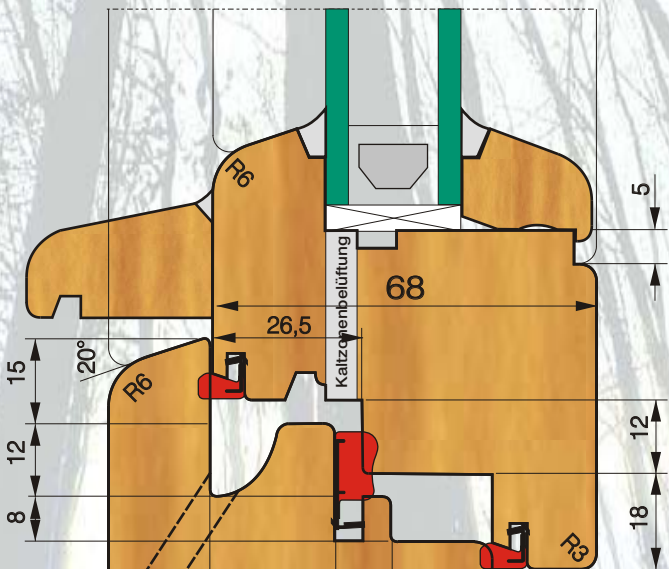
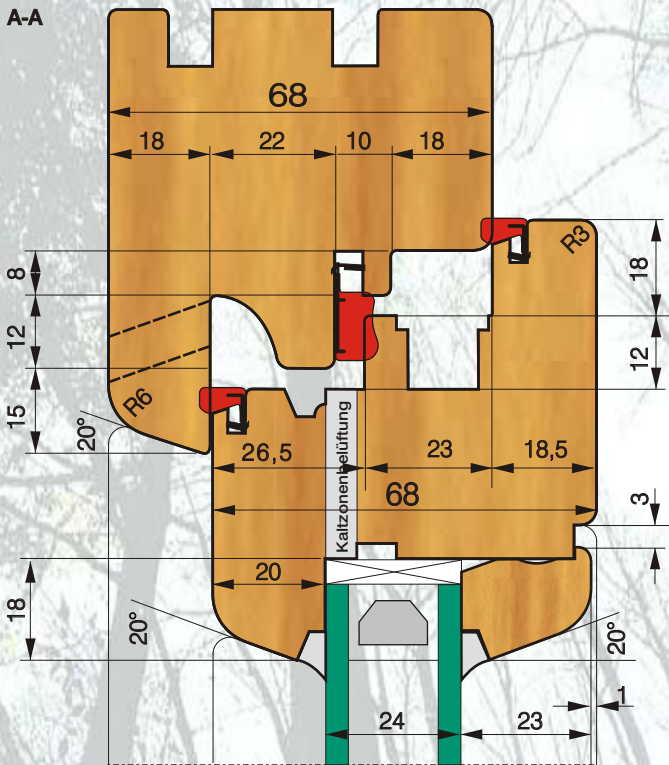

QL-3053

Falz Rebate: 12mm
Nute Groove: 4-5x8mm
Spalt Gap: 5mm

Überschlagdichtung
2nd sash-seal

QL-3034

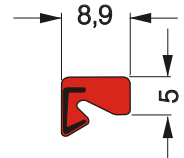

Falz Rebate:
Nute Groove: 3x5mm
Spalt Gap:

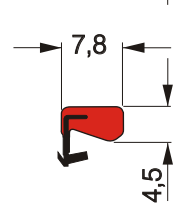

QL-3070

Falz Rebate:
Nute Groove: 3x5mm
Spalt Gap:

Stulpdichtung
Seal for FRENCH windows

DX-1362



Falz Rebate: 18-20mm
Nute Groove: 4-5x8mm
Spalt Gap:

Dichtung Sealing strips **QL-3109**

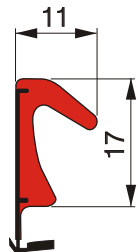

Falz Rebate: 18mm
Nute Groove: 5x7mm
Spalt Gap: 5-8mm

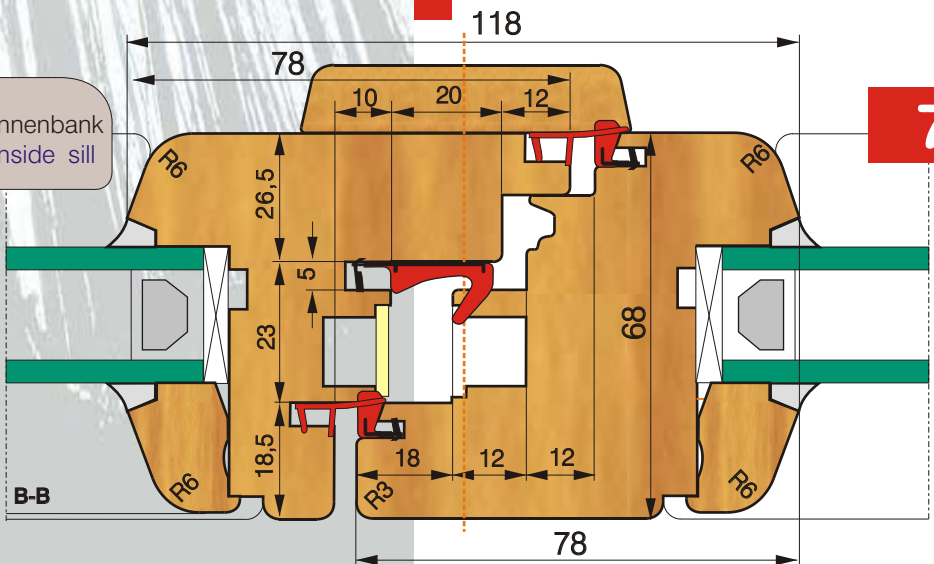

IV68 FENSTER MIT ANGEFRÄSTER GLASLEISTE
IV68 WINDOW WITH FIXED GLAZING BEAD

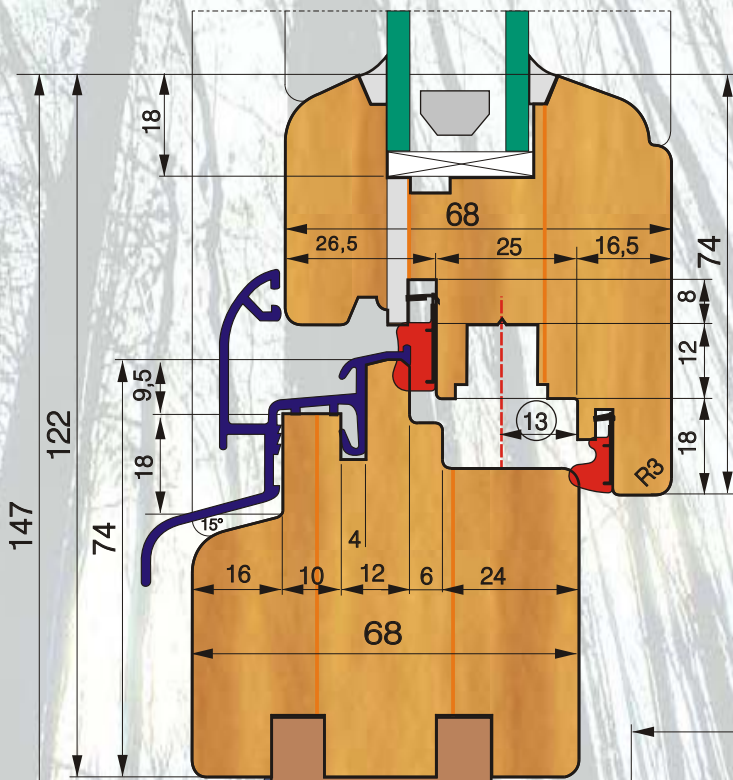
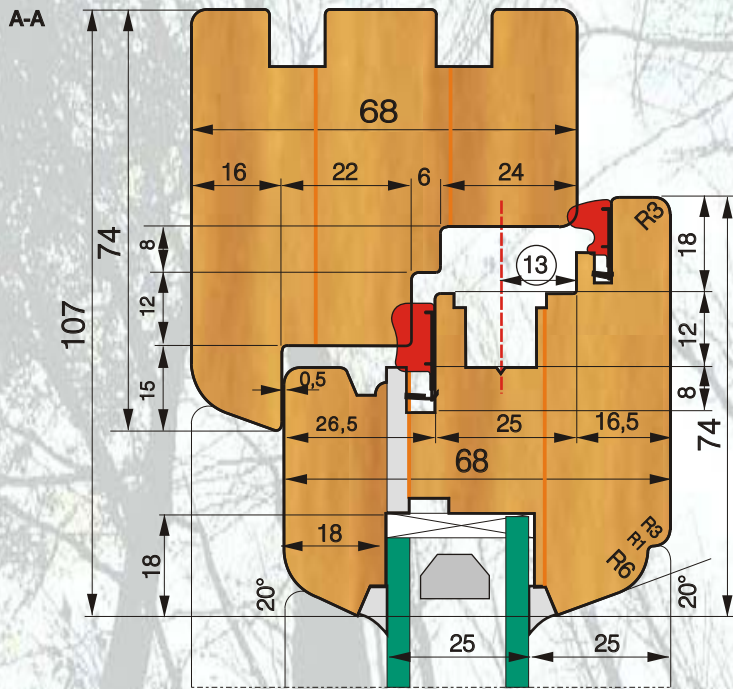

Außenbank
 Outside sill

Leiste oder
 Konstruktionsdämmstoff
 35X40mm
 genutet

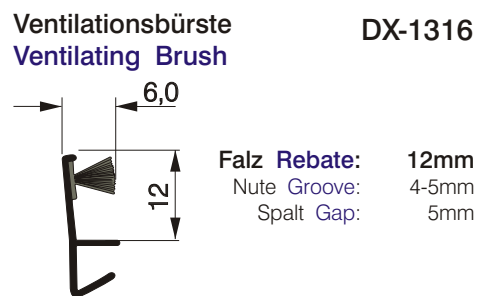
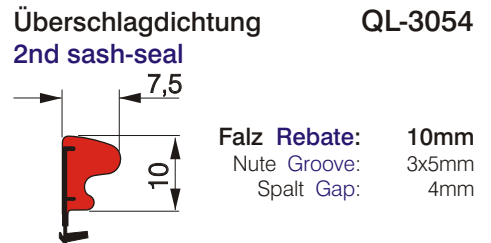
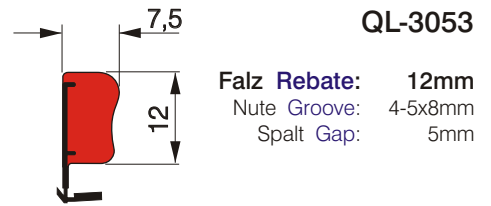
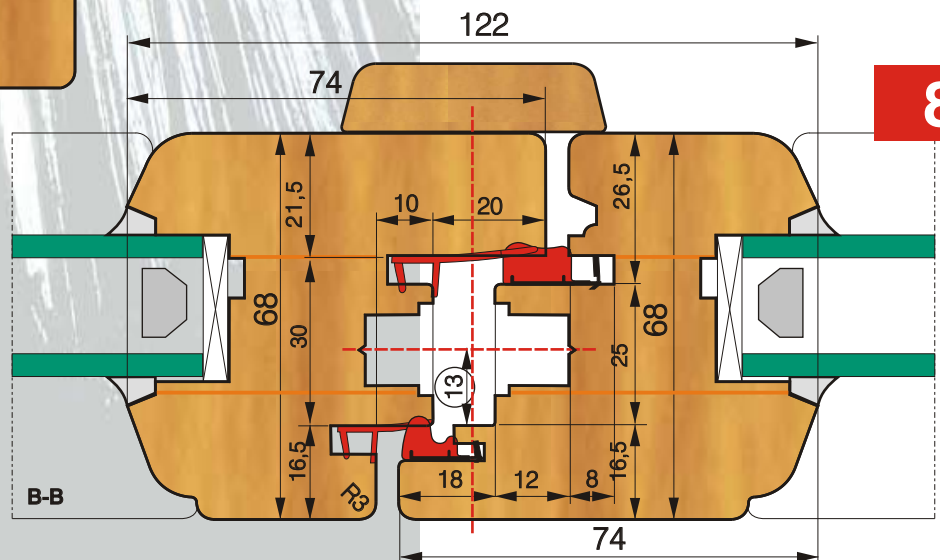
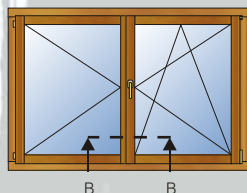

IV101 PASSIVHAUS FENSTER
IV101 HIGH INSULATION WINDOW "PASSIV HOUSE"

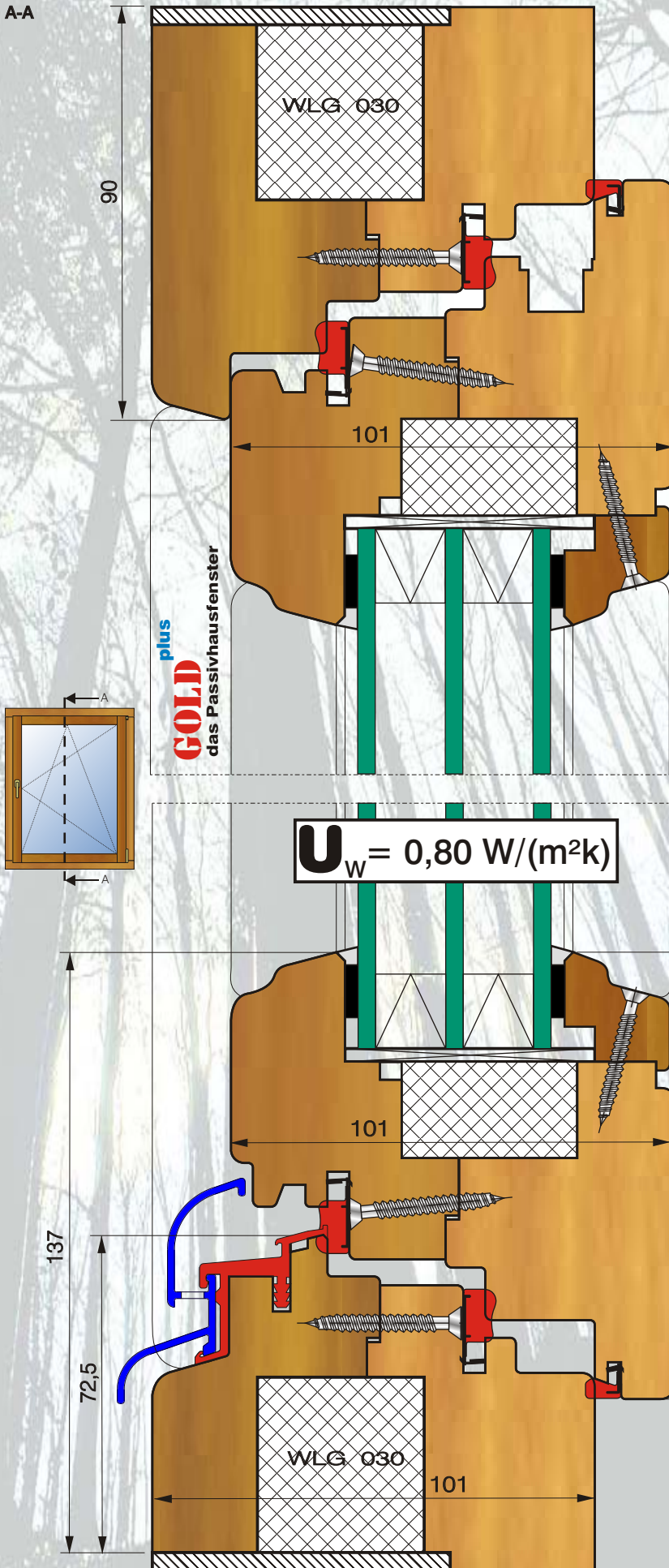

U_w = 0,80 W/(m²k)

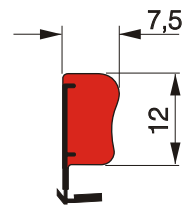

QL-3053

Falz Rebate: 12mm
 Nute Groove: 4-5x8mm
 Spalt Gap: 5mm

Überschlagdichtung
 2nd sash-seal

QL-3034

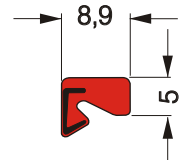

Falz Rebate: 3x5mm
 Nute Groove: 3x5mm
 Spalt Gap: 3x5mm

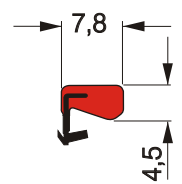

QL-3070

Falz Rebate: 3x5mm
 Nute Groove: 3x5mm
 Spalt Gap: 3x5mm

Die Fenster-Konstruktion ist vom
 Patentamt München
 gebrauchsmustergeschützt
 mit Nr. 201 02 772.0

IV68 WENDE FENSTER
IV68 CENTRE PIVOT WINDOW

A-A

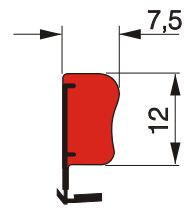
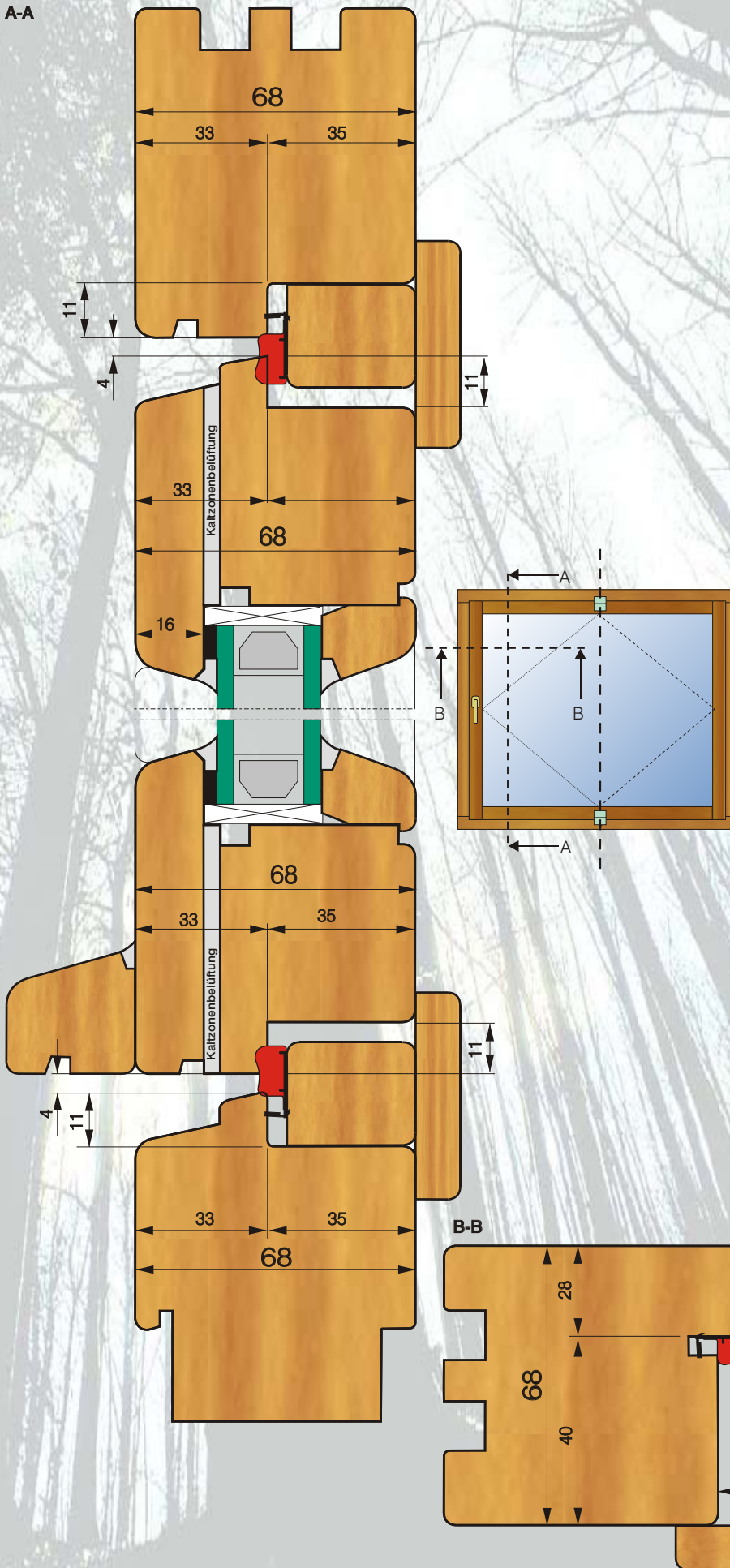

QL-3053

Falz Rebate: 12mm
 Nute Groove: 4-5x8mm
 Spalt Gap: 5mm

QL-3076

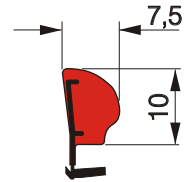

Falz Rebate: 10mm
 Nute Groove: 3-3,5x8mm
 Spalt Gap: 4mm

Der Wendeflügel wird am oberen und unteren Rahmen-Querholz gelagert.
 Centre of rotation: Midpoint of the bottom and top rail



IV68 SCHWING FENSTER
IV68 PIVOT WINDOW

A-A

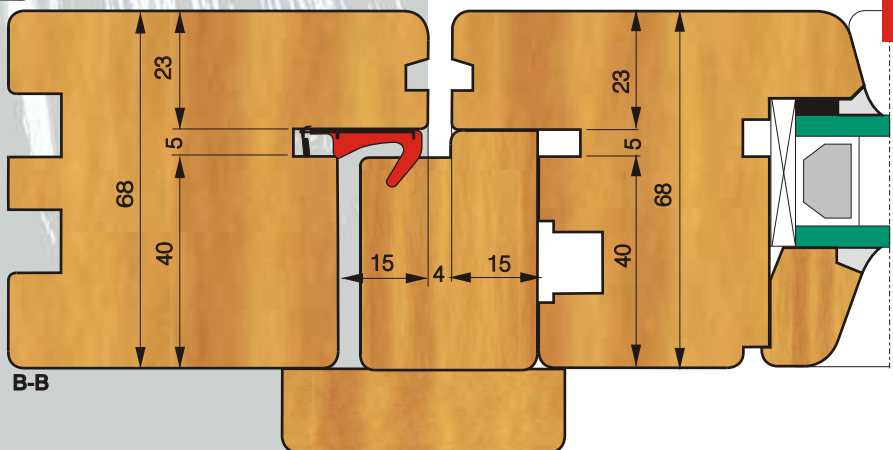
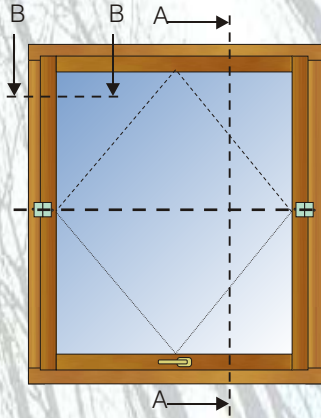
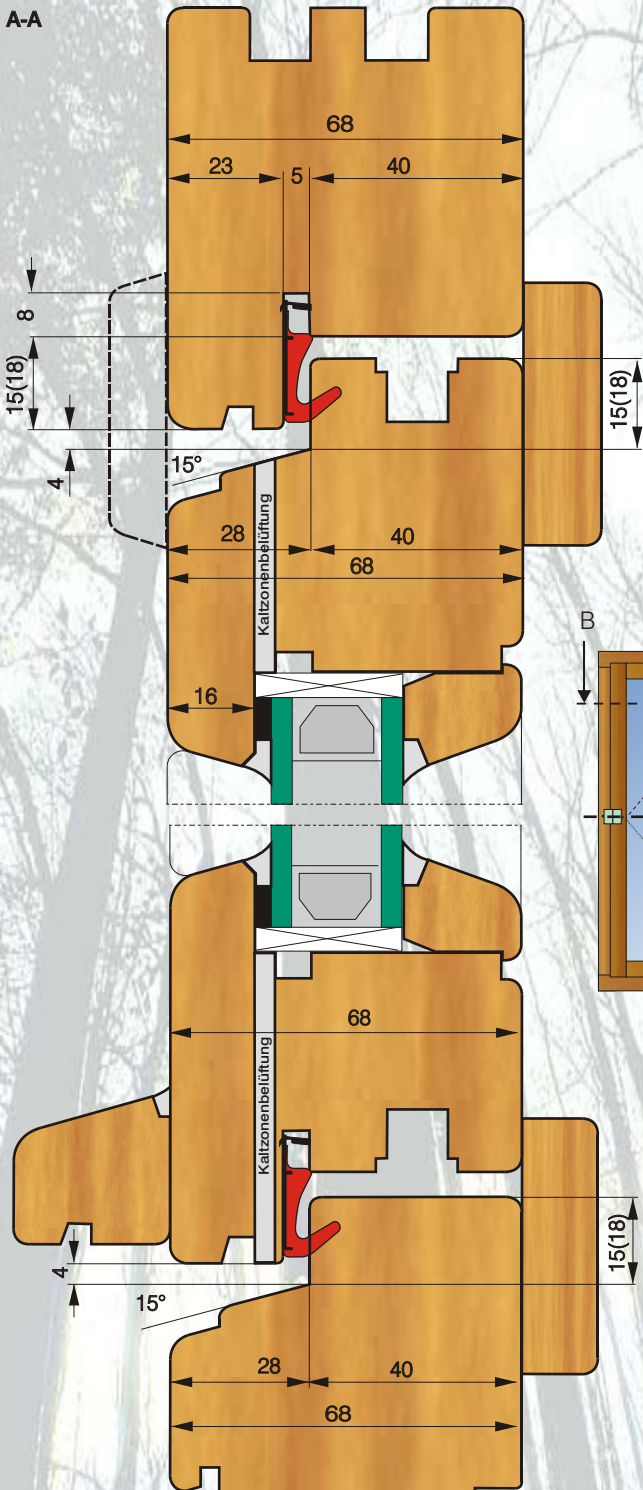

B-B



QL-3091

Falz Rebate: 15mm
 Nute Groove: 4-5x7mm
 Spalt Gap: 5mm

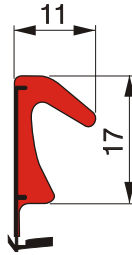

QL-3109

Falz Rebate: 18mm
 Nute Groove: 5x8mm
 Spalt Gap: 5-8mm



EV44/42/94 RUSSISCHES KASTENFENSTER
EV44/42/94 RUSSIAN DOUBLE WINDOW

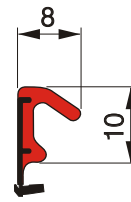

QL-3094
 QL-3095

Falz Rebate: 10mm
 Nute Groove: 3-4x5mm
 Spalt Gap: 3-4mm

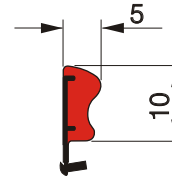

QL-3072
 QL-3079

Falz Rebate: 10mm
 Nute Groove: 3-4x7mm
 Spalt Gap: 3mm



2 ODER 3 FLÜGELIG
 2 OR 3 SASH

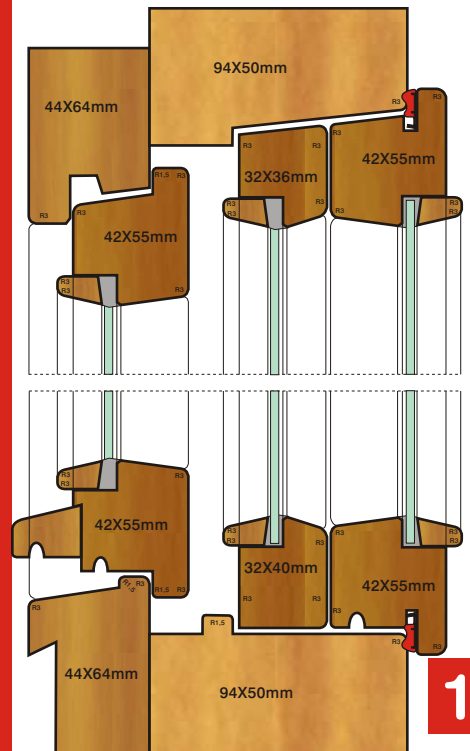

EV68/68 KASTENFENSTER "ST.PETERSBURG"
EV68/68 BOX TYPE WINDOW "ST.PETERSBURG"

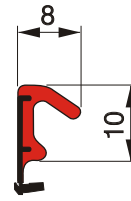
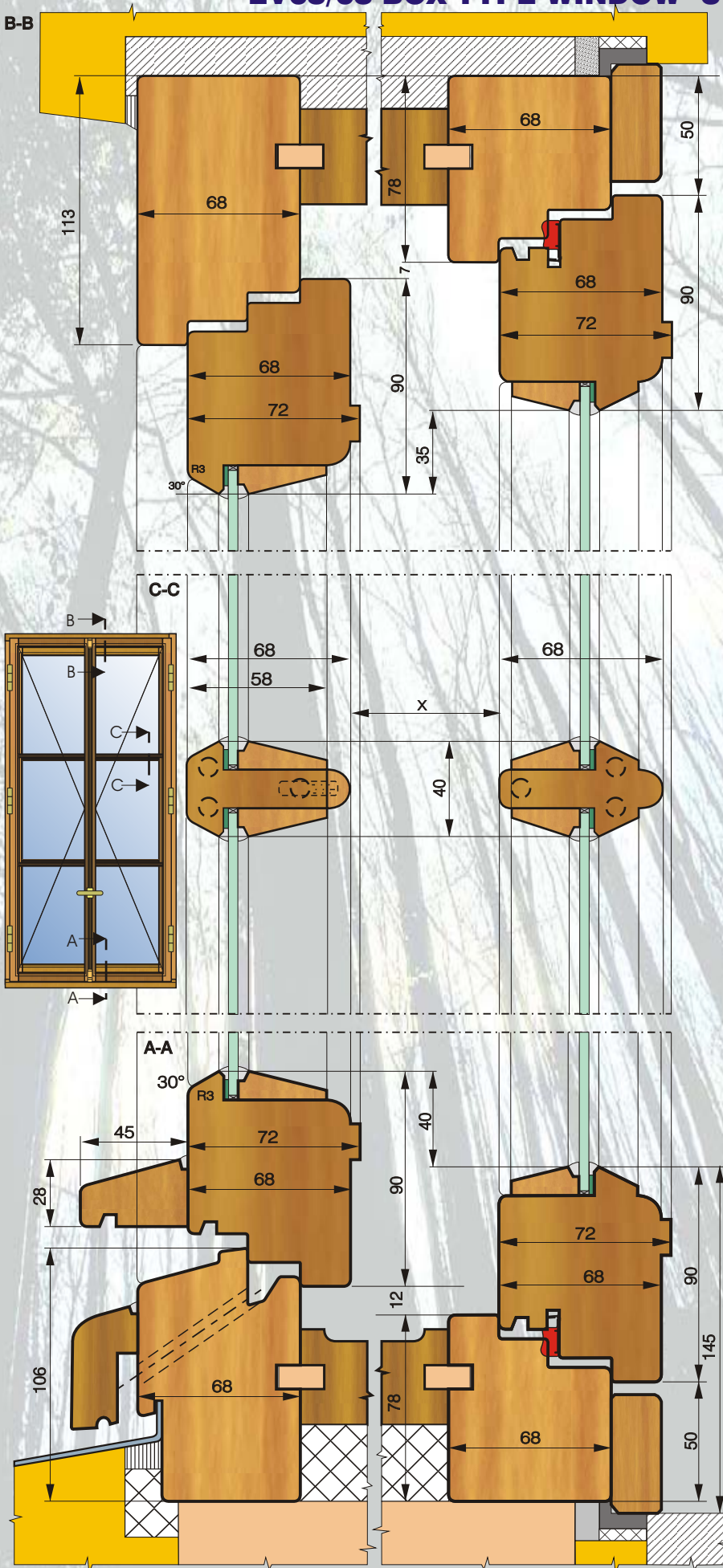

QL-3094
 QL-3095

Falz Rebate: 10mm
 Nute Groove: 3-4x5mm
 Spalt Gap: 3-4mm

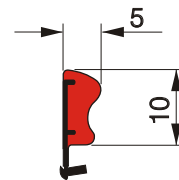

QL-3072
 QL-3079

Falz Rebate: 10mm
 Nute Groove: 3-4x7mm
 Spalt Gap: 3mm



IV92/66,5 NORWEGISCHES FENSTER
IV92/66,5 NORWEGIAN WINDOW

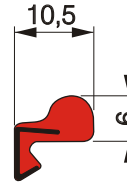
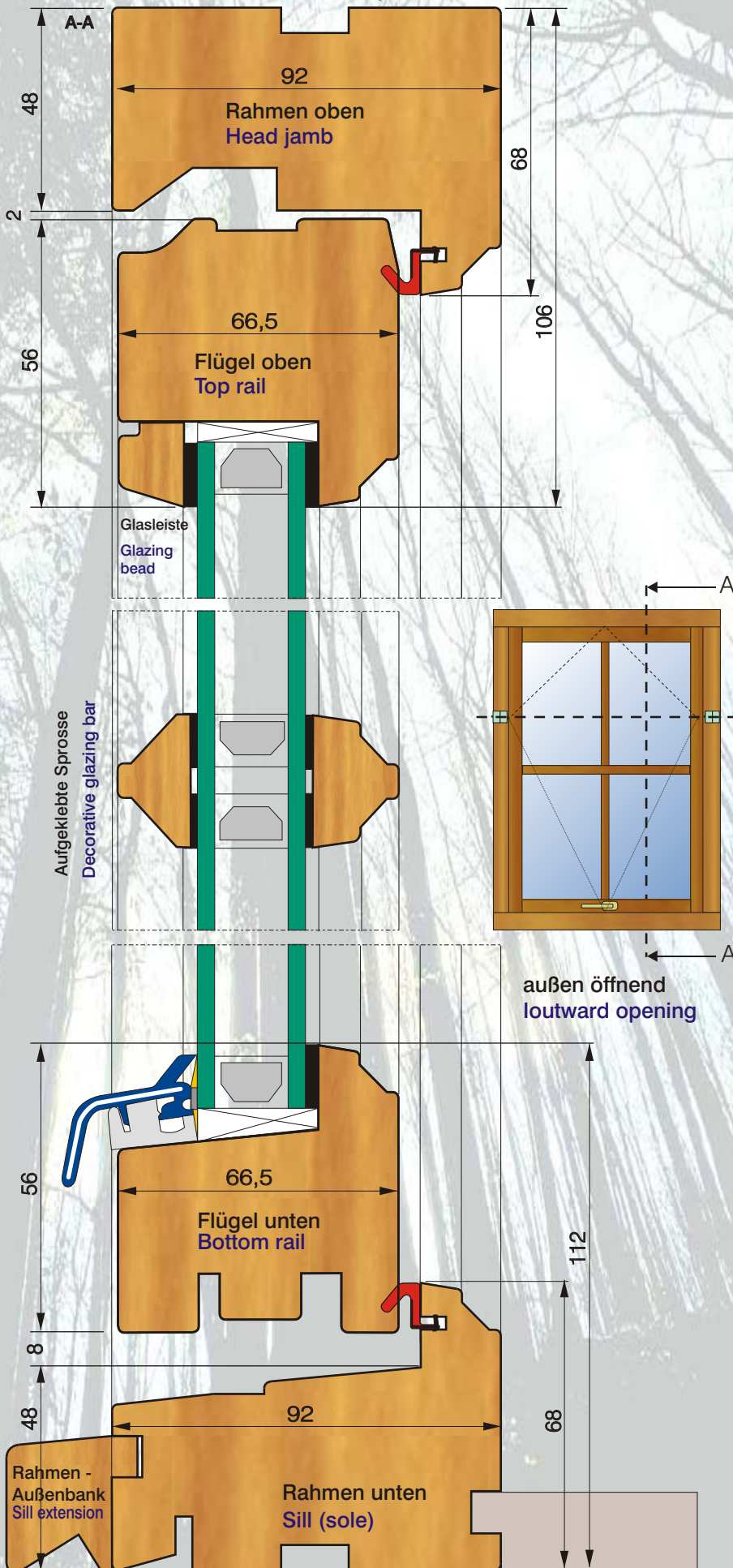

QL-3004

Falz Rebate: 10mm
 Nute Groove: 3x7mm
 Spalt Gap: 4mm

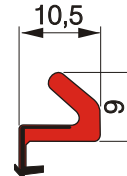

QL-3078

Falz Rebate: 10-11mm
 Nute Groove: 3x7mm
 Spalt Gap: 4mm

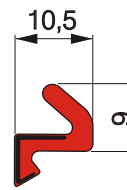

QL-3056

Falz Rebate: 10mm
 Nute Groove: 3x7mm
 Spalt Gap: 4mm

außen öffnend
 loutward opening

IV16/56 DÄNISCHES FENSTER
IV16/56 DANISH WINDOW



QL-3073

Falz Rebate: 13mm
 Nute Groove: 4-5x8mm
 Spalt Gap: 5mm

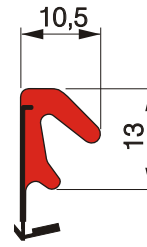

QL-3102

Falz Rebate: 10mm
 Nute Groove: 4x8mm
 Spalt Gap: 5mm

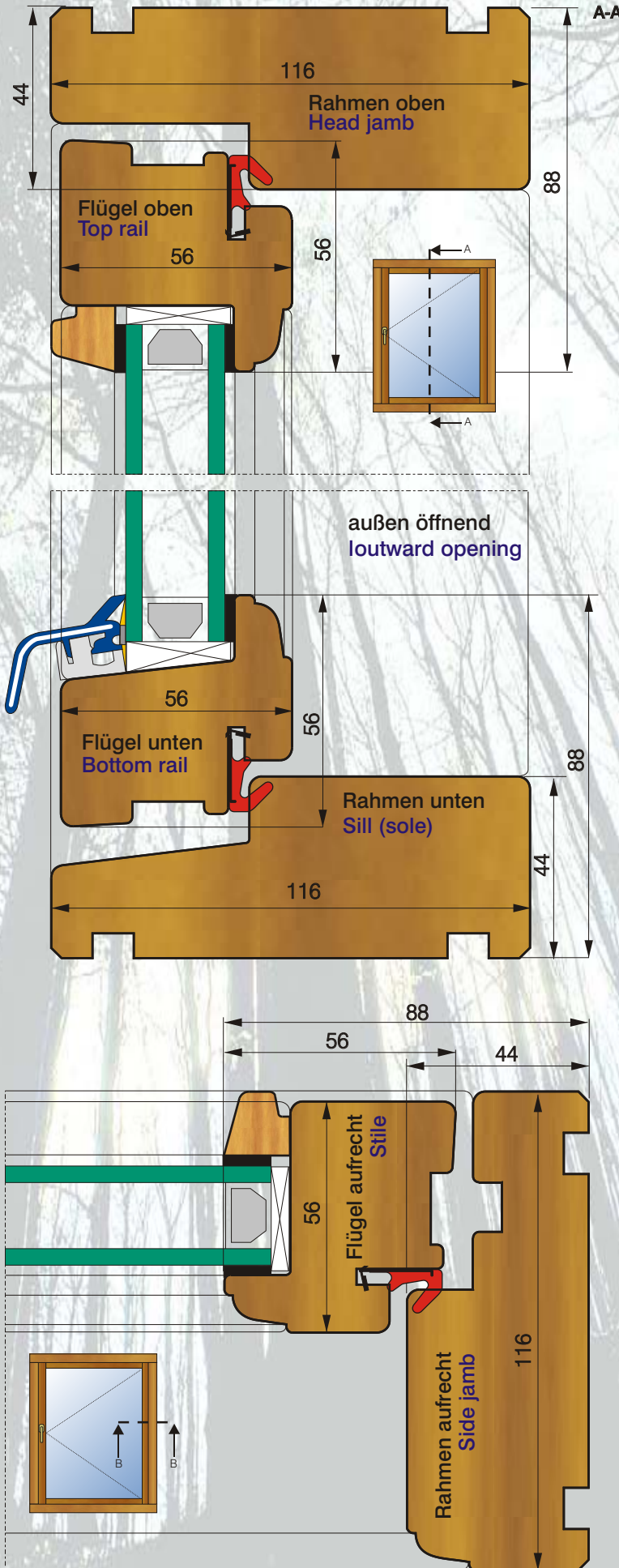
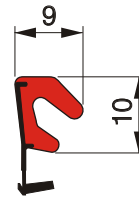

EV115/32IV55 SCHWEDISCHES FENSTER
EV115/32IV55 SWEDISH WINDOW



KFI innen öffnend
 KFI inward opening

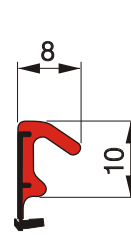
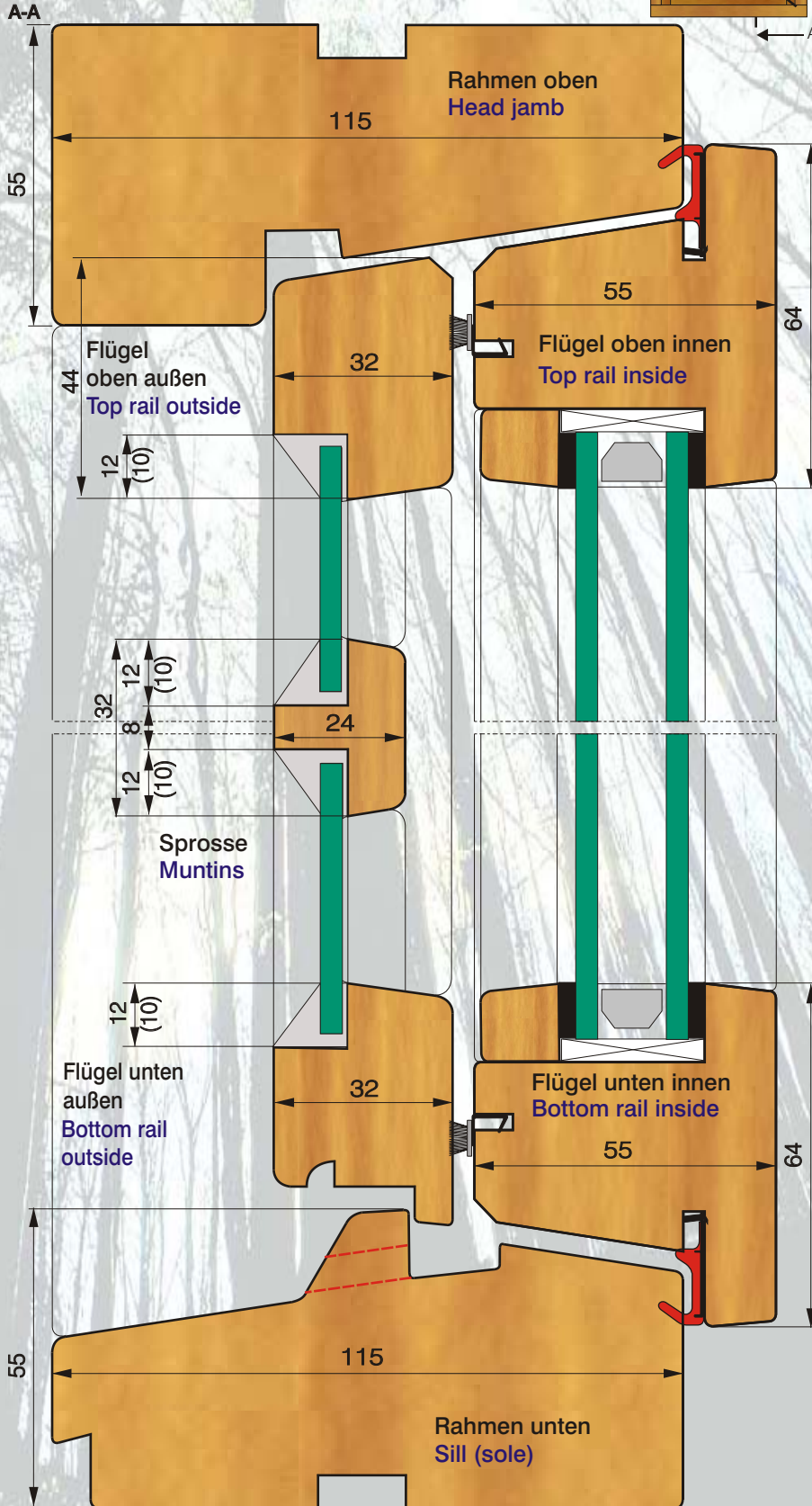
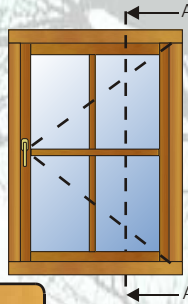

QL-3094
 QL-3095

Falz Rebate: 10mm
 Nute Groove: 3-4x5mm
 Spalt Gap: 3-4mm

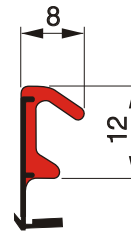

QL-3096

Falz Rebate: 12mm
 Nute Groove: 4-5x7mm
 Spalt Gap: 3-6mm

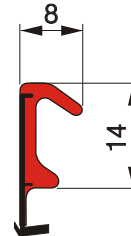

QL-3098

Falz Rebate: 14mm
 Nute Groove: 4x7mm
 Spalt Gap: 3-6mm

Staubfilter-Bürste
 Dust Filter Brush

DX-1372

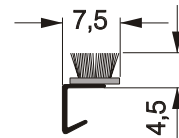

Falz Rebate:
 Nute Groove: 3x7mm
 Spalt Gap: 3-4mm



EV115/32IV55 SCHWEDISCHES FENSTER
EV115/32IV55 SWEDISH WINDOW

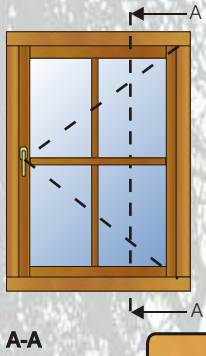

KFU außen öffnend
 KFU outward opening

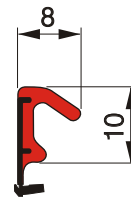
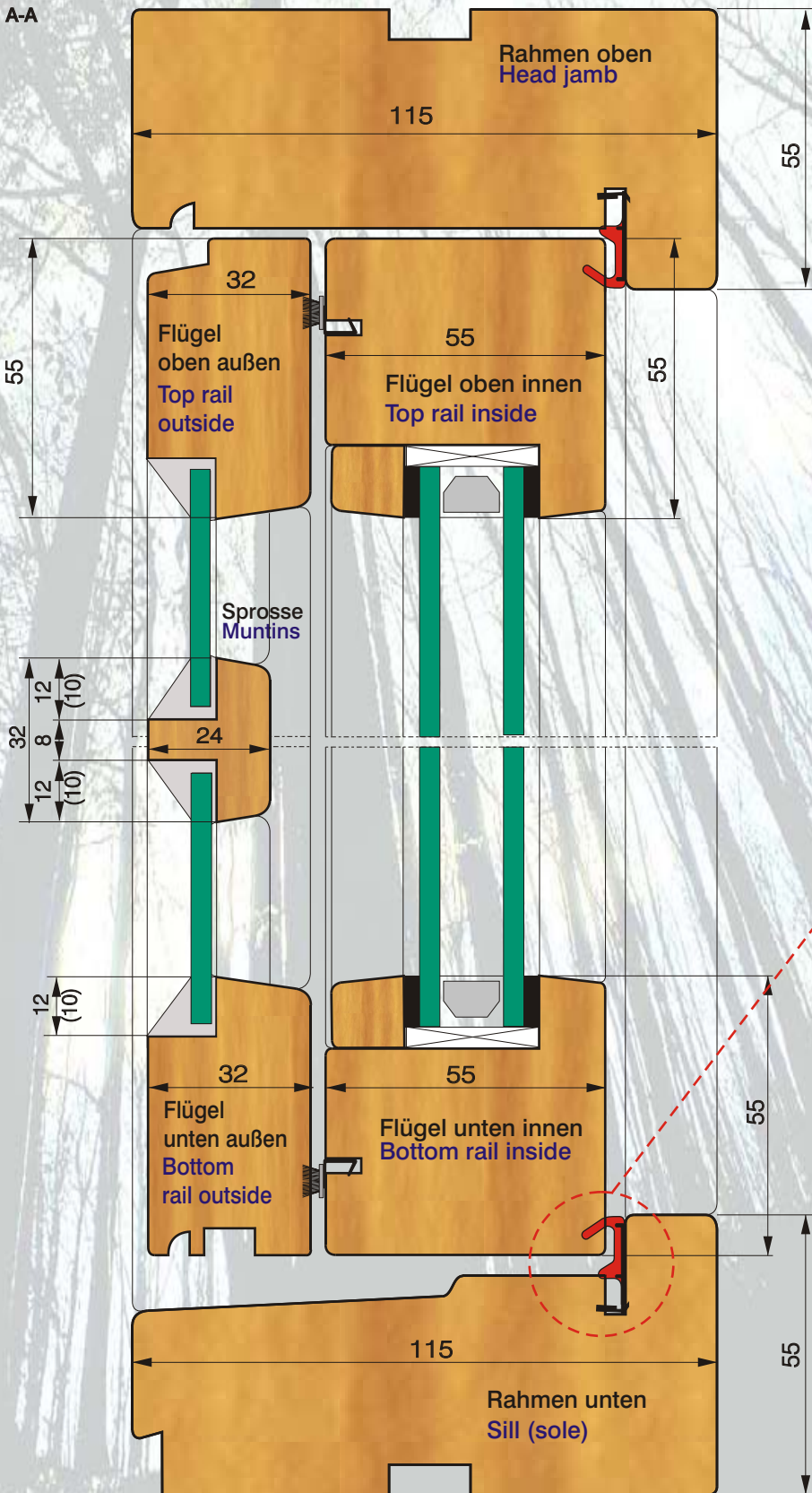

QL-3094
QL-3095

Falz Rebate: 10mm
 Nute Groove: 3-4x5mm
 Spalt Gap: 3-4mm

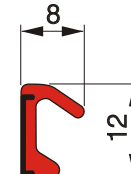

QL-3096

Falz Rebate: 12mm
 Nute Groove: 4-5x7mm
 Spalt Gap: 3-4mm

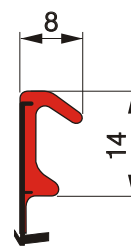

QL-3098

Falz Rebate: 14mm
 Nute Groove: 4x7mm
 Spalt Gap: 3-4mm

Staubfilter-Bürste
 Dust Filter Brush

DX-1372

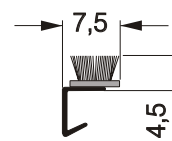

Falz Rebate:
 Nute Groove: 3x7mm
 Spalt Gap: 3-4mm

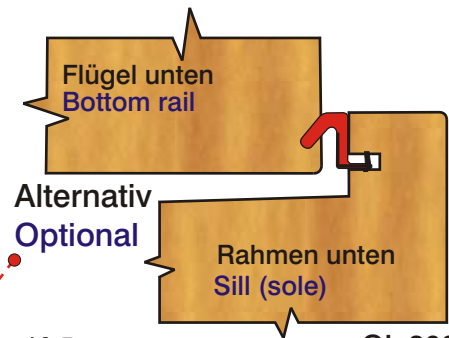

QL-3004

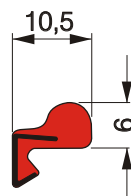

Falz Rebate: 10mm
 Nute Groove: 3x7mm
 Spalt Gap: 4mm

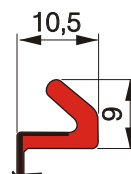

QL-3078

Falz Rebate: 10-11mm
 Nute Groove: 3x7mm
 Spalt Gap: 4mm

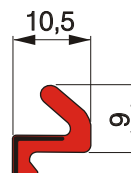

QL-3056

Falz Rebate: 10mm
 Nute Groove: 3x7mm
 Spalt Gap: 4mm

IV125/56 VERTIKAL SCHIEBE FENSTER
IV126/56 DOUBLE - HUNG WINDOW

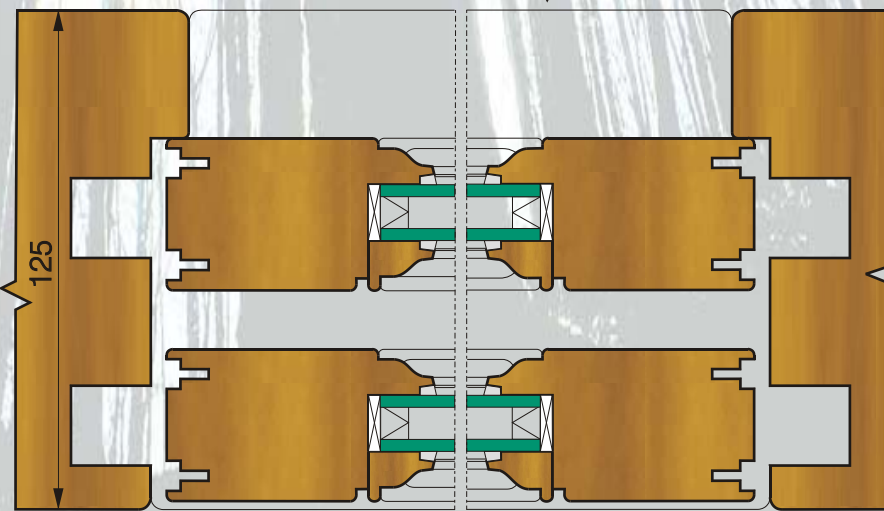
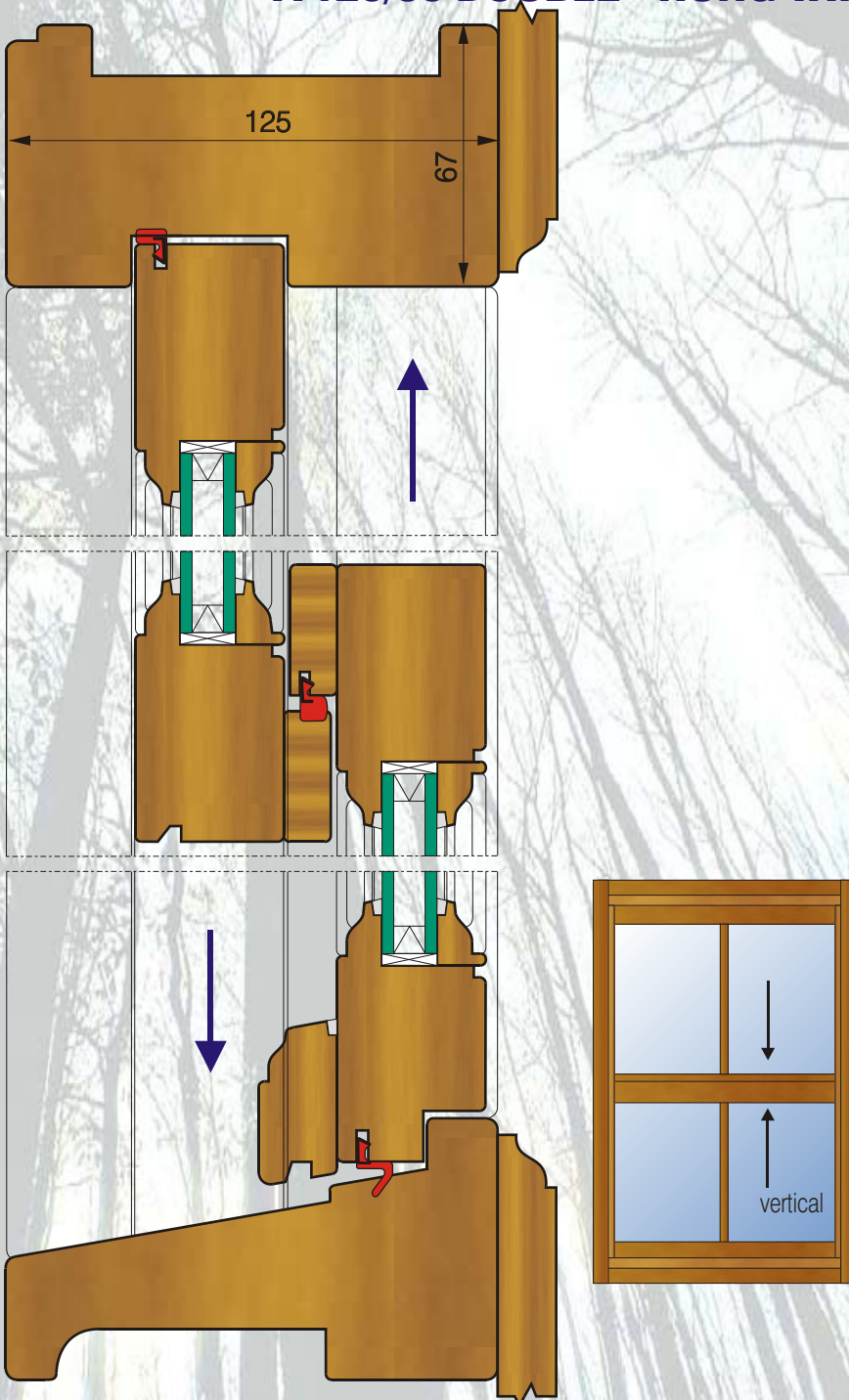

QL-3078

Falz Rebate: 10-11mm
 Nute Groove: 3x7mm
 Spalt Gap: 4mm

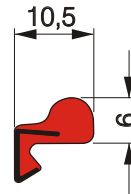

QL-3004

Falz Rebate: 10mm
 Nute Groove: 3x7mm
 Spalt Gap: 4mm

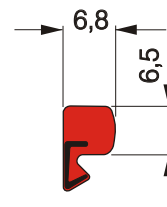

QL-3005

Falz Rebate: min.8mm
 Nute Groove: 3x6mm
 Spalt Gap: 4mm

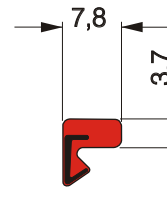

QL-3013

Falz Rebate: min.8mm
 Nute Groove: 3x6mm
 Spalt Gap: 2-3mm

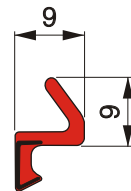

QL-3055

Falz Rebate: 9mm
 Nute Groove: 3x7mm
 Spalt Gap: 4mm



QL-3011

Falz Rebate: 10mm
 Nute Groove: 3x7mm
 Spalt Gap: 4mm

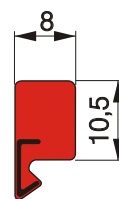

QL-3012

Falz Rebate: 11mm
 Nute Groove: 3x7mm
 Spalt Gap: 5mm



QL-3037

Falz Rebate: 10mm
 Nute Groove: 3x7mm
 Spalt Gap: 4mm



IV1 10/42 FINNISCHES HOLZ-ALU FENSTER
IV1 10/42 FINNISH WOOD-ALU WINDOW

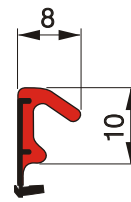
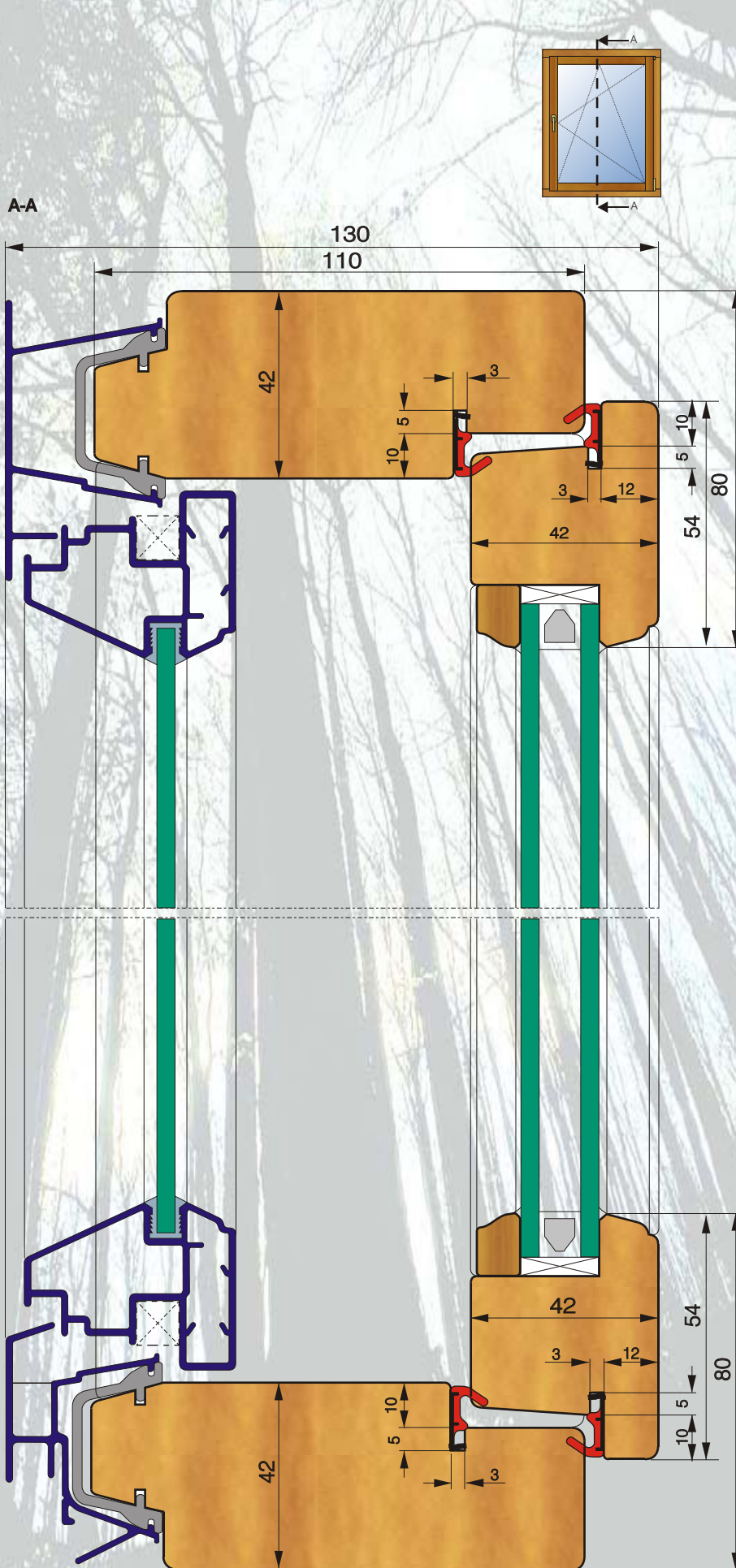

QL-3094

Falz Rebate: 10mm
 Nute Groove: 3x5mm
 Spalt Gap: 3-4mm

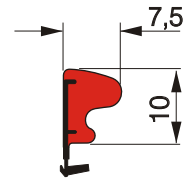

QL-3054

Falz Rebate: 10mm
 Nute Groove: 3x5mm
 Spalt Gap: 4mm

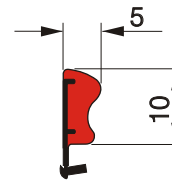

QL-3072

Falz Rebate: 10mm
 Nute Groove: 3x7mm
 Spalt Gap: 3mm

IV68 HAUSTÜRE IN HOLZ FENSTER-BASIS
IV68 WOODEN FRONT DOOR BASED ON WINDOW

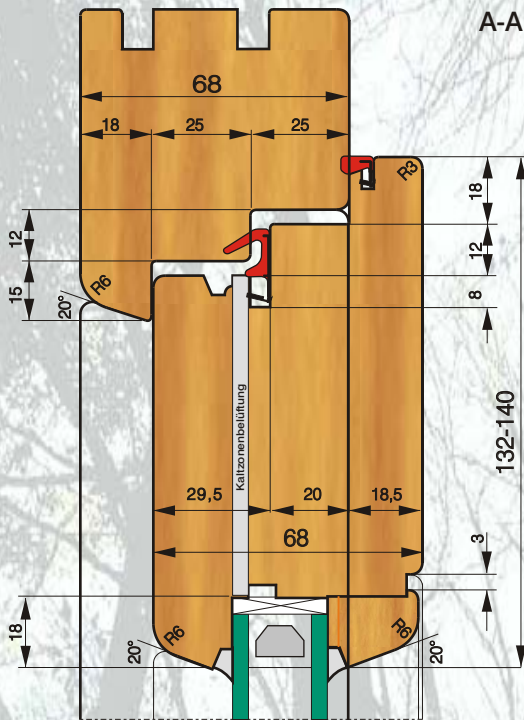

A-A

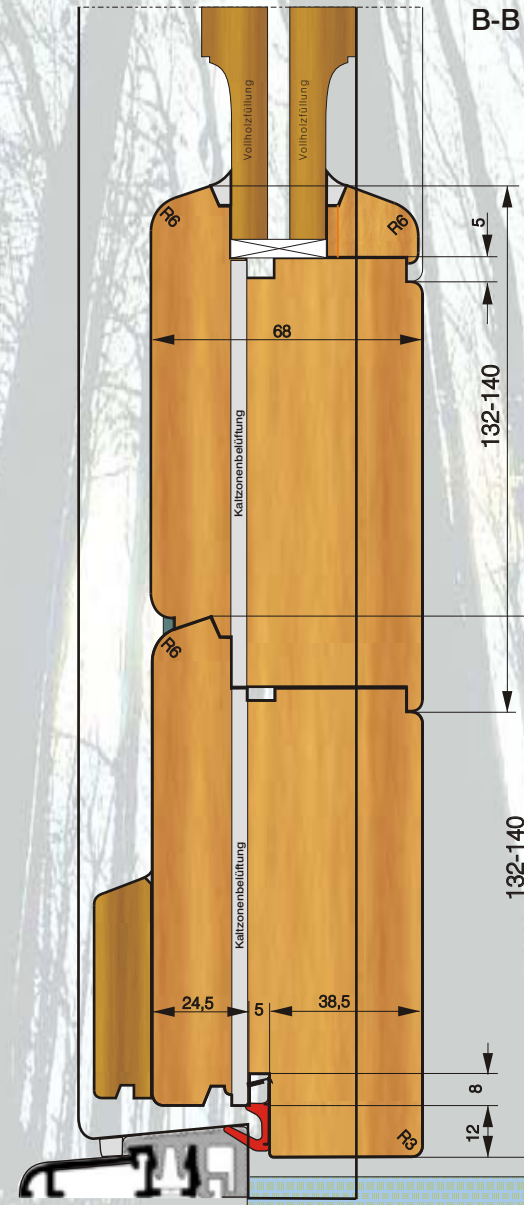
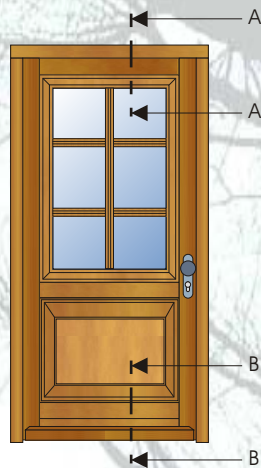

B-B



QL-3104

Falz Rebate: 12mm
 Nute Groove: 4-5x7mm
 Spalt Gap: 5-6mm

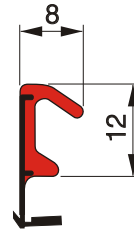

QL-3096

Falz Rebate: 12mm
 Nute Groove: 4-5x7mm
 Spalt Gap: 3-6mm

Überschlagdichtung
2nd sash-seal

QL-3034

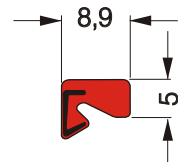

Falz Rebate:
 Nute Groove: 3x5mm
 Spalt Gap:

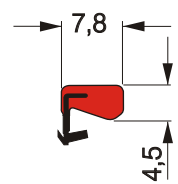

QL-3070

Falz Rebate:
 Nute Groove: 3x5mm
 Spalt Gap:

IV68 HAUSTÜRE IN HOLZ EINFACHFALZ
IV68 WOODEN FRONT DOOR SINGLE REBATE

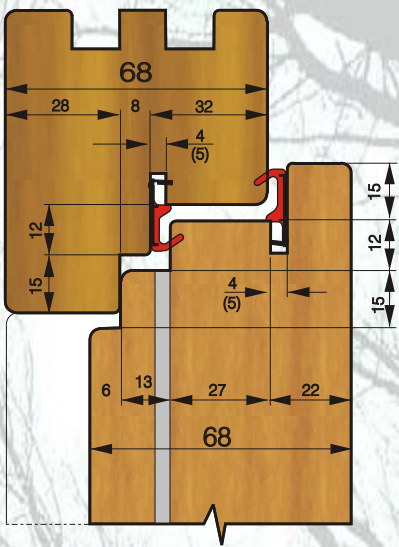
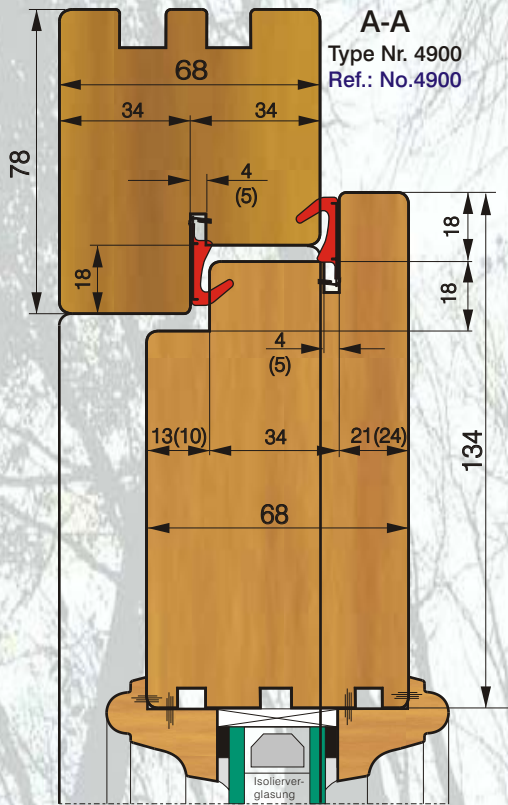

Auch für Type Nr. 4500
 As well for Ref.: No.4500

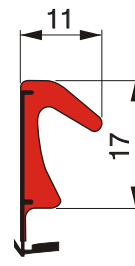
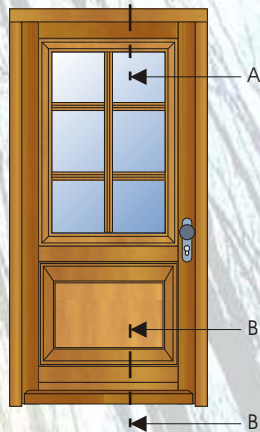
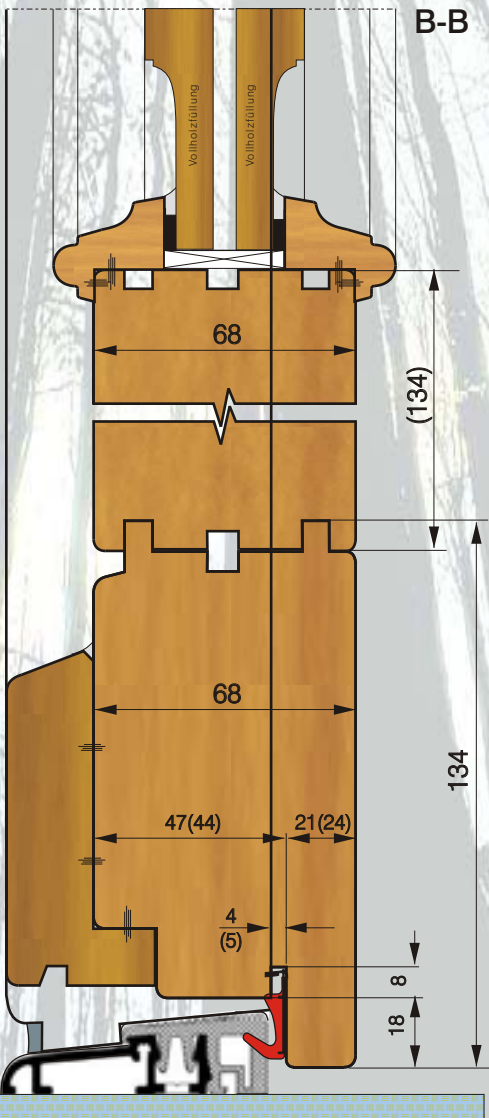

QL-3109

Falz Rebate: 18mm
Nute Groove: 5x7mm
Spalt Gap: 5-8mm

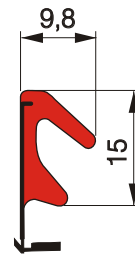

QL-3091

Falz Rebate: 15mm
Nute Groove: 4-5x7mm
Spalt Gap: 5mm

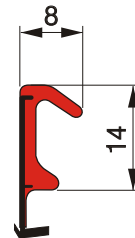

QL-3098

Falz Rebate: 14mm
Nute Groove: 4x7mm
Spalt Gap: 3-6mm

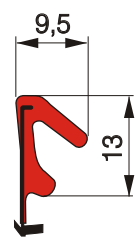

QL-3093

Falz Rebate: 13mm
Nute Groove: 3x7mm
Spalt Gap: 4-5mm



QL-3104

Falz Rebate: 12mm
Nute Groove: 4-5x7mm
Spalt Gap: 5-6mm

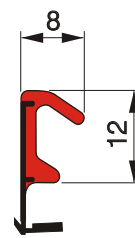

QL-3096

Falz Rebate: 12mm
Nute Groove: 4-5x7mm
Spalt Gap: 3-6mm

IV67 HAUSTÜRE IN HOLZ EINFACHFALZ
IV67 WOODEN FRONT DOOR SINGLE REBATE

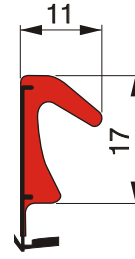
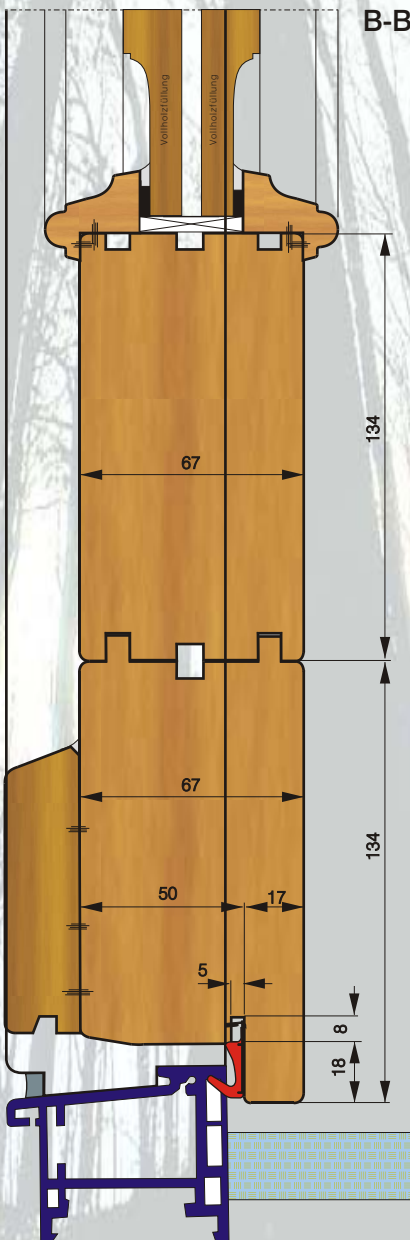
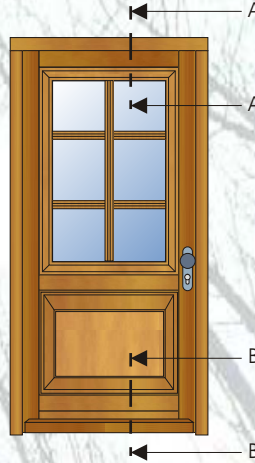
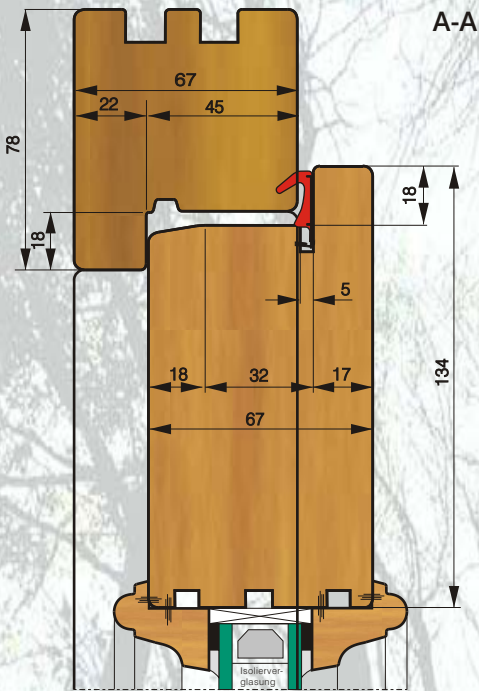

QL-3109

Falz Rebate: 18mm
Nute Groove: 5x7mm
Spalt Gap: 5-8mm

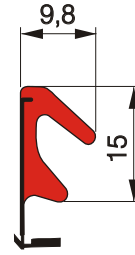

QL-3091

Falz Rebate: 15mm
Nute Groove: 4-5x7mm
Spalt Gap: 5mm

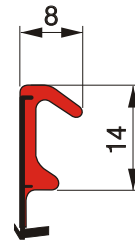

QL-3098

Falz Rebate: 14mm
Nute Groove: 4x7mm
Spalt Gap: 3-6mm

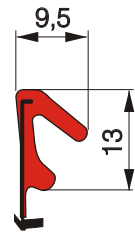

QL-3093

Falz Rebate: 13mm
Nute Groove: 3x7mm
Spalt Gap: 4-5mm



QL-3104

Falz Rebate: 12mm
Nute Groove: 4-5x7mm
Spalt Gap: 5-6mm

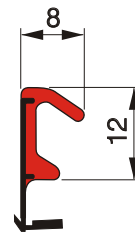

QL-3096

Falz Rebate: 12mm
Nute Groove: 4-5x7mm
Spalt Gap: 3-6mm

IV68 HAUSTÜRE IN HOLZ AUSSEN ÖFFNEND
IV68 WOODEN FRONT DOOR OUTWARD OPENING

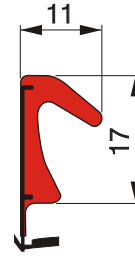
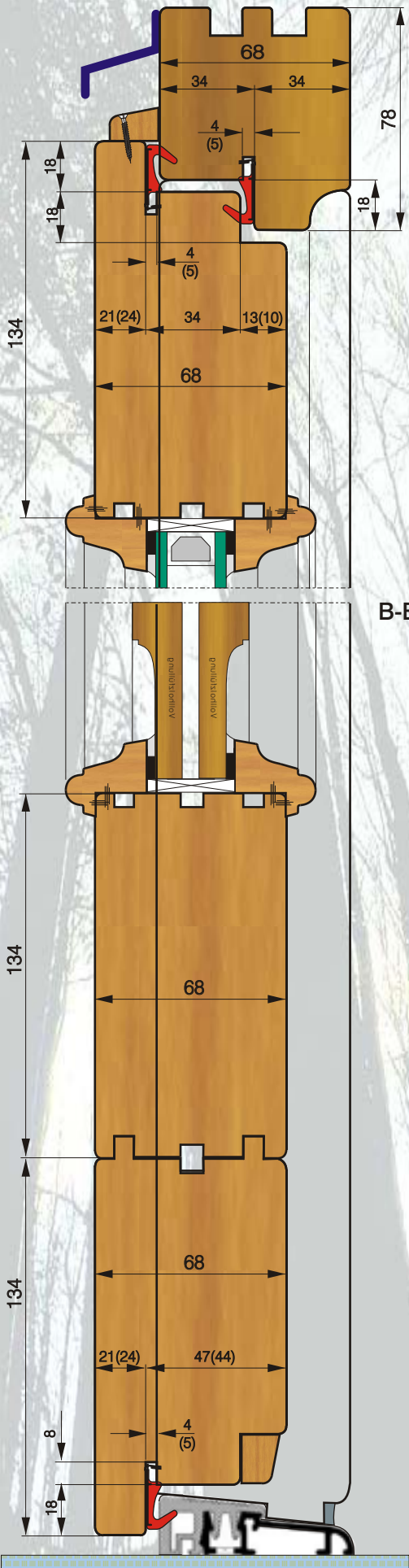

QL-3109

Falz Rebate: 18mm
 Nute Groove: 5x7mm
 Spalt Gap: 5-8mm

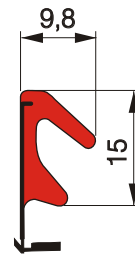

QL-3091

Falz Rebate: 15mm
 Nute Groove: 4-5x7mm
 Spalt Gap: 5mm

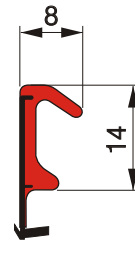

QL-3098

Falz Rebate: 14mm
 Nute Groove: 4x7mm
 Spalt Gap: 3-6mm

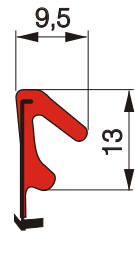

QL-3093

Falz Rebate: 13mm
 Nute Groove: 3x7mm
 Spalt Gap: 4-5mm



QL-3104

Falz Rebate: 12mm
 Nute Groove: 4-5x7mm
 Spalt Gap: 5-6mm

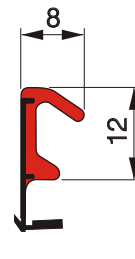

QL-3096

Falz Rebate: 12mm
 Nute Groove: 4-5x7mm
 Spalt Gap: 3-6mm

IV116/56 SKANDINAVISCHES HAUSTÜR
IV116/56 SCANDINAVIAN FRONT DOOR

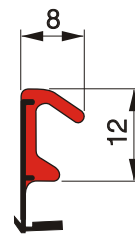
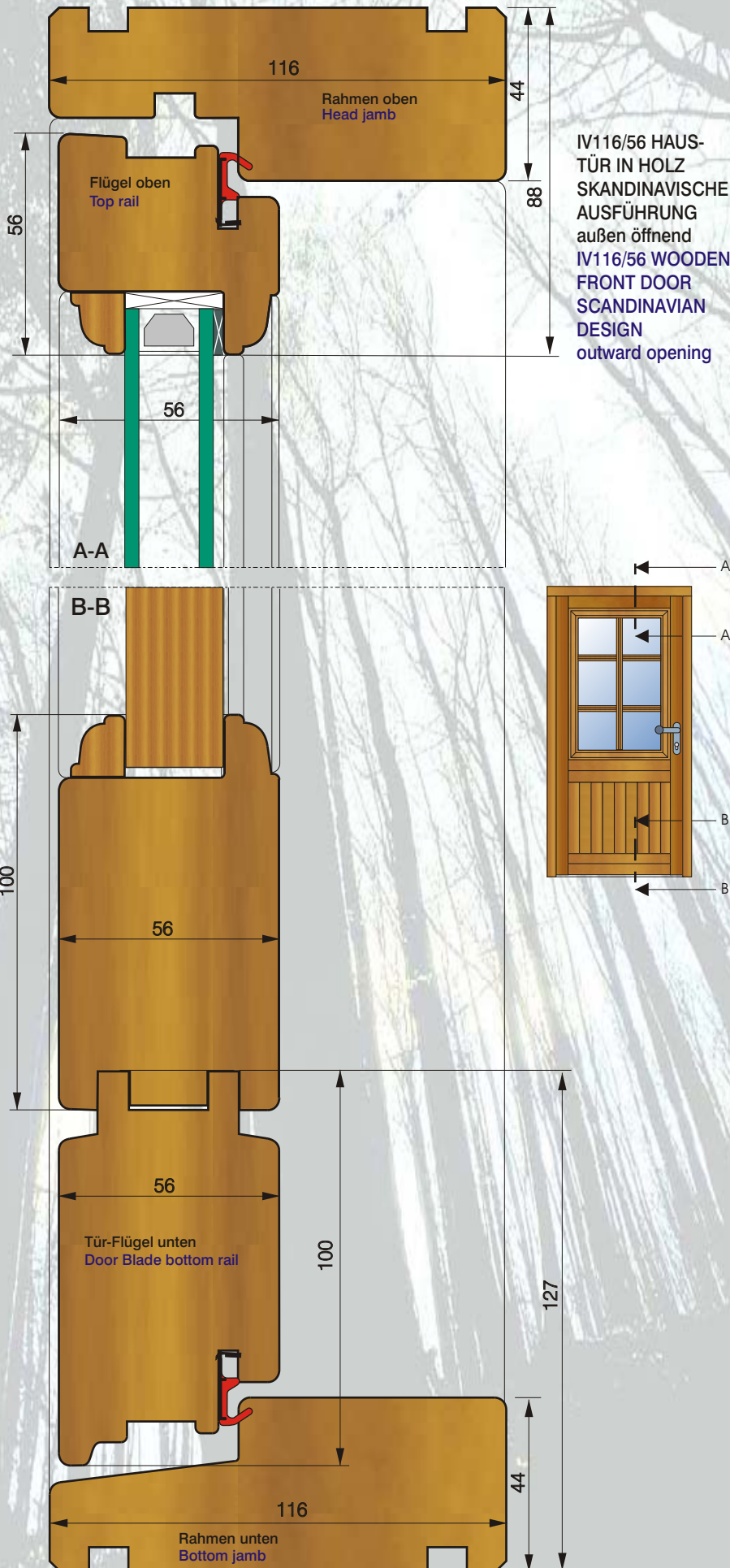

QL-3096

Falz Rebate: 12mm
 Nute Groove: 4-5x7mm
 Spalt Gap: 3-6mm



QL-3104

Falz Rebate: 12mm
 Nute Groove: 4-5x7mm
 Spalt Gap: 5-6mm

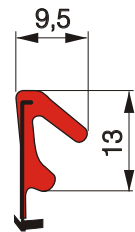

QL-3093

Falz Rebate: 13mm
 Nute Groove: 3x7mm
 Spalt Gap: 4-5mm

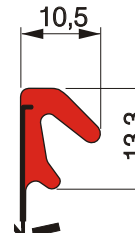

QL-3073

Falz Rebate: 13mm
 Nute Groove: 5x8mm
 Spalt Gap: 5mm

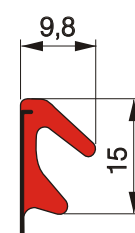

QL-3091

Falz Rebate: 15mm
 Nute Groove: 5x7mm
 Spalt Gap: 5mm

Türschwelle-Dichtung
 Threshold seal

DX-959

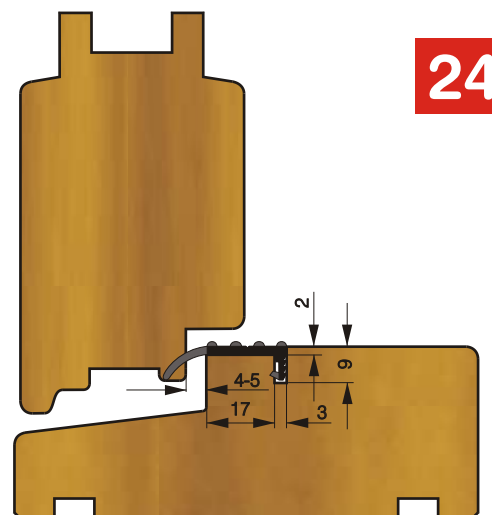

IV130/63 FINNISCHE HAUSTÜRE
IV130/63 FINNISH FRONT DOOR

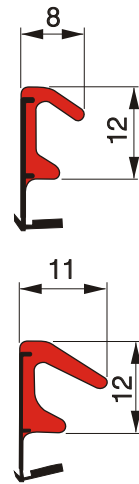
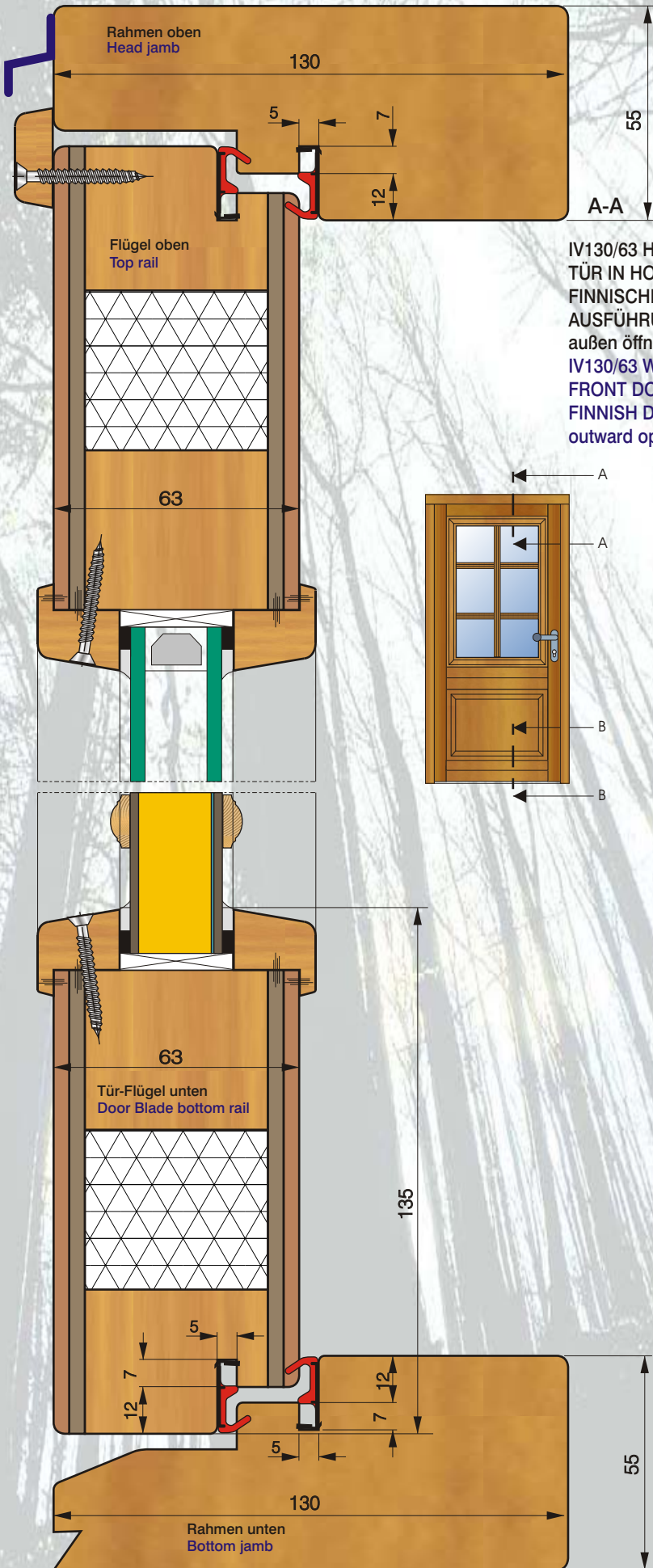

QL-3096

Falz Rebate: 12mm
 Nute Groove: 4-5x7mm
 Spalt Gap: 3-6mm

QL-3104

Falz Rebate: 12mm
 Nute Groove: 4-5x7mm
 Spalt Gap: 5-6mm

Türschwelle-Dichtung
 Threshold seal

DX-959

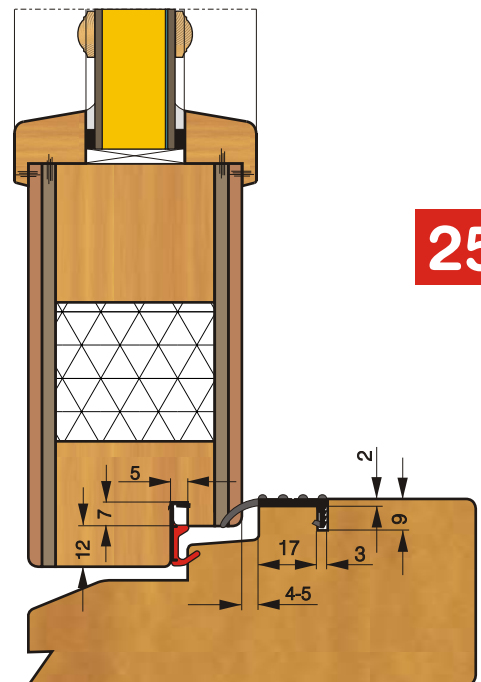

IV56/68 HEBE-SCHIEBE-TÜR
IV56/68 LIFT-SLIDE-DOOR

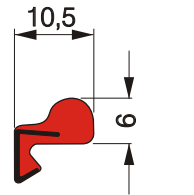
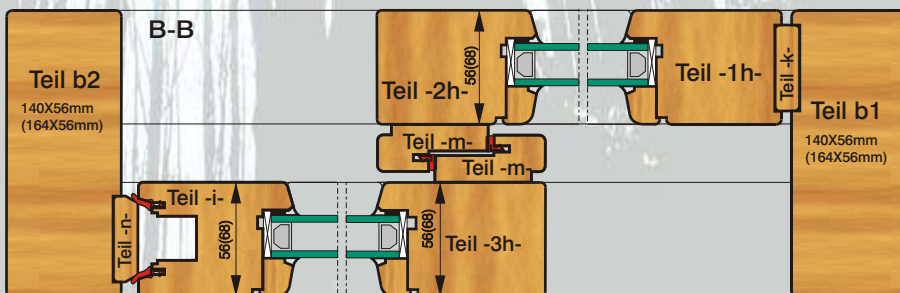
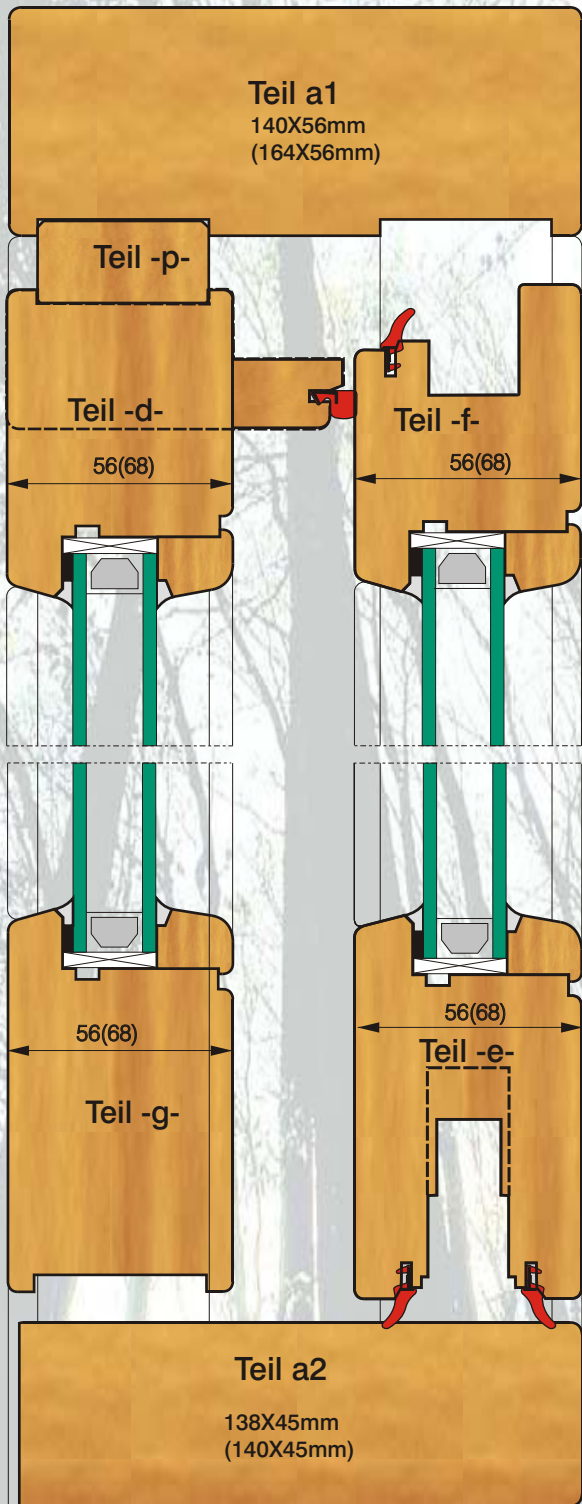

QL-3004

Falz Rebate: 10mm
 Nute Groove: 3-7x8mm
 Spalt Gap: 4mm

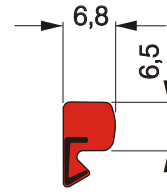

QL-3005

Falz Rebate: min.8mm
 Nute Groove: 3x6mm
 Spalt Gap: 4mm

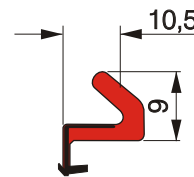

QL-3078

Falz Rebate: 10-11mm
 Nute Groove: 3x6mm
 Spalt Gap: 4mm

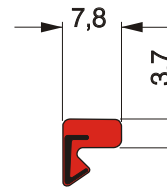

QL-3013

Falz Rebate: min.8mm
 Nute Groove: 3x6mm
 Spalt Gap: 2-3mm

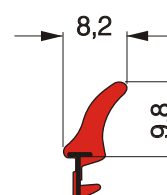

QL-9111

Falz Rebate: -
 Nute Groove: 3,2x6,5mm
 Spalt Gap: 4,8-7,9mm

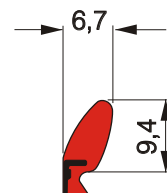

QL-5626

Falz Rebate: -
 Nute Groove: 2,7x6mm
 Spalt Gap: 4,7-7,5mm

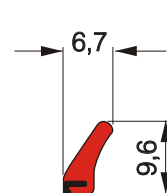

QL-7066

Falz Rebate: -
 Nute Groove: 2,7x6mm
 Spalt Gap: 4,8-7,7mm

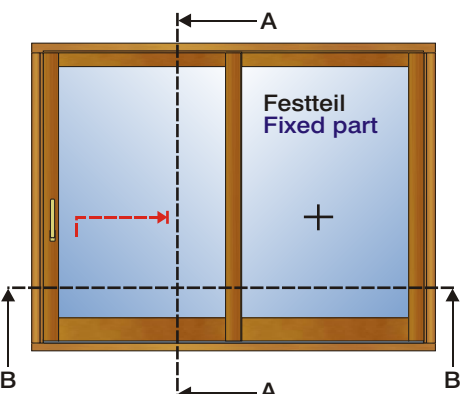

26/40 INNENTÜRE - TÜRFUTTER AUSFÜHRUNG
26/40 INTERIOR DOORS - DOOR CASE DESIGN

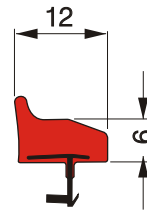
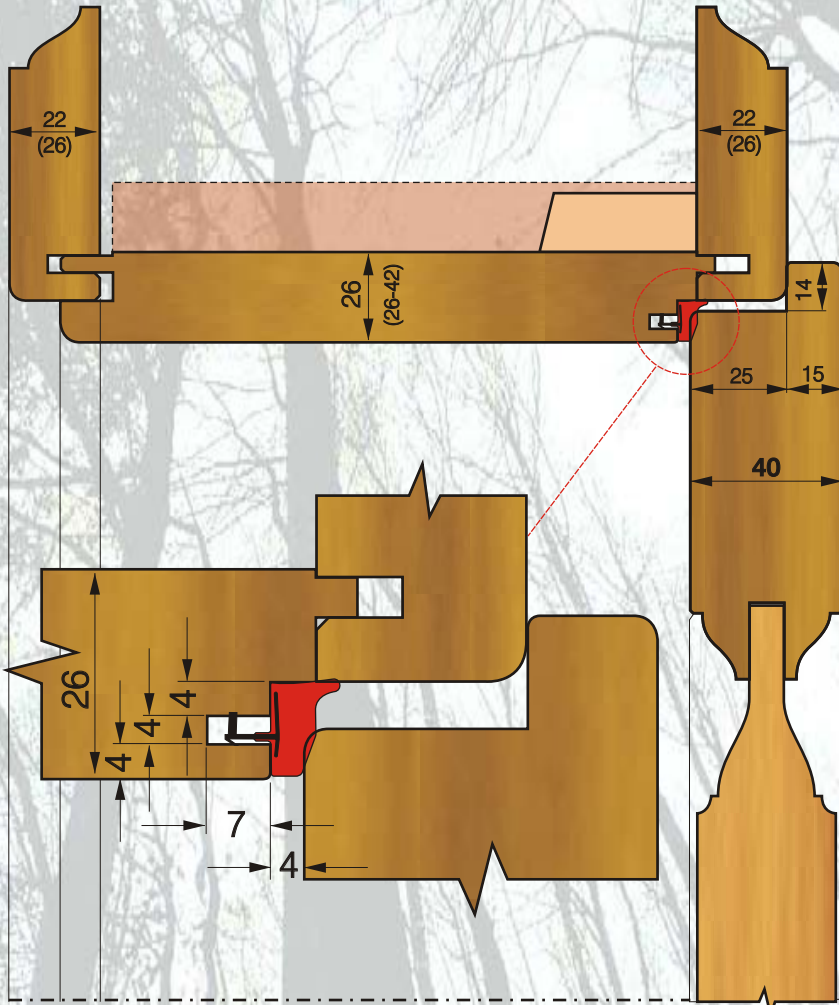

QL-3110

Falz Rebate: 12mm
 Nute Groove: 4x7mm
 Spalt Gap: 5mm

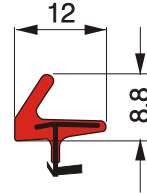

QL-3100

Falz Rebate: 12mm
 Nute Groove: 4x7mm
 Spalt Gap: 5-7mm

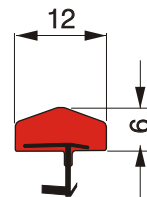

QL-3106

Falz Rebate: 12mm
 Nute Groove: 4x7mm
 Spalt Gap: 5mm

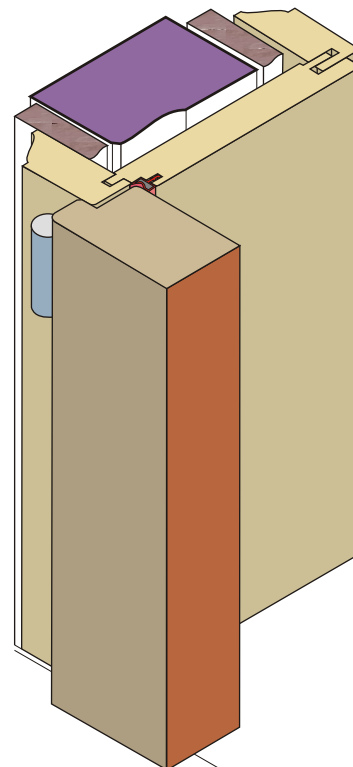

54/40 NEBENEINGANGSTÜRE BLOCKFUTTER
54/40 SIDE-ENTRANCE DOOR - DOOR FRAME

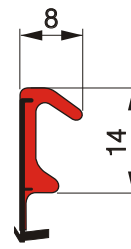
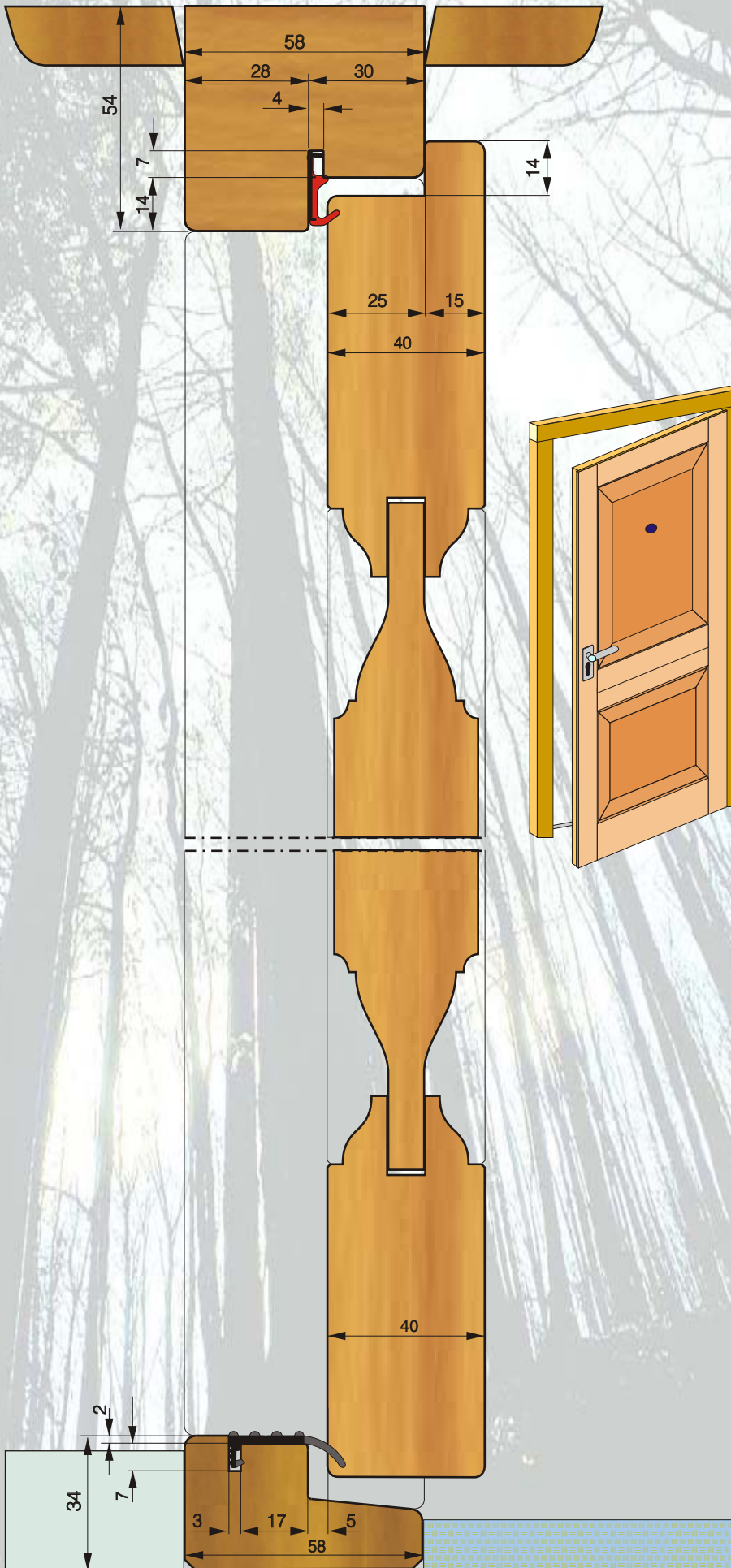

QL-3098

Falz Rebate: 14mm
 Nute Groove: 4x7mm
 Spalt Gap: 3-6mm

Türschwelle-Dichtung DX-959
 Threshold seal

